

JVC

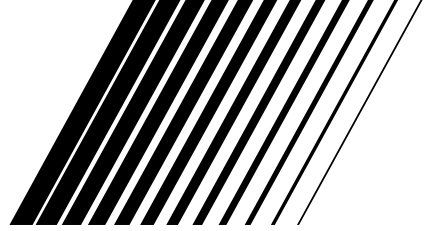

COMPACT COMPONENT SYSTEM

CA-DXU20

CA-DXU9

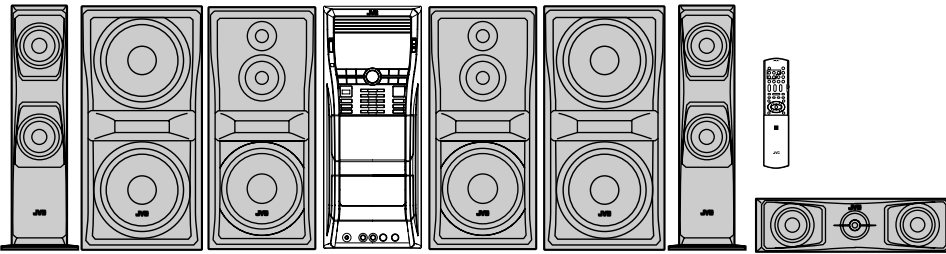

CA-DXU20

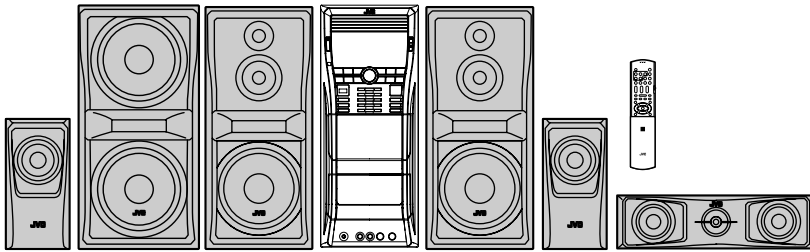

CA-DXU9



MP3/WMA/WAV Digital Direct Progressive Scan **V**ario **BASS**



INSTRUCTIONS

Warnings, Cautions and Others

CAUTION

To reduce the risk of electrical shocks, fire, etc.:

1. Do not remove screws, covers or cabinet.
2. Do not expose this appliance to rain or moisture.

CAUTION

The \odot/I button in any position does not disconnect the mains line.

Disconnect the mains plug to shut the power off completely (the STANDBY lamp goes off).

The MAINS plug or an appliance coupler is used as the disconnect device, the disconnect device shall remain readily operable.

- When the system is on standby, the STANDBY lamp lights red.
- When the system is turned on, the STANDBY lamp goes off.

The power can be remote controlled.

CAUTION

- Do not block the ventilation openings or holes.

(If the ventilation openings or holes are blocked by a newspaper or cloth, etc., the heat may not be able to get out.)

- Do not place any naked flame sources, such as lighted candles, on the apparatus.
- When discarding batteries, environmental problems must be considered and local rules or laws governing the disposal of these batteries must be followed strictly.
- Do not expose this apparatus to rain, moisture, dripping or splashing and that no objects filled with liquids, such as vases, shall be placed on the apparatus.

CAUTION

Excessive sound pressure from earphones or headphones can cause hearing loss.

CAUTION

Battery shall not be exposed to excessive heat such as sunshine, fire or the like.

IMPORTANT FOR LASER PRODUCTS

1. CLASS 1 LASER PRODUCT

2. **CAUTION:** Do not open the top cover or cabinet. There are no user serviceable parts inside the unit; leave all servicing to qualified service personnel.

3. **CAUTION:** Visible and/or invisible class 1M laser radiation when open. Do not view directly with optical instruments.

4. REPRODUCTION OF LABEL: CAUTION LABEL, PLACED INSIDE THE UNIT.

| CAUTION | ATTENTION | AVISO | VARNING | 注意 | CAUTION |
|--|--|---|--|--|--|
| VISIBLE AND/OR INVISIBLE CLASS 1M LASER RADIATION WHEN OPEN, DO NOT VIEW DIRECTLY WITH OPTICAL INSTRUMENTS. IEC60825-1:2001 (EN3) | RAYONNEMENT LASER VISIBLE ET/OU INVISIBLE DE CLASSE 1M UNE FOIS OUVERT, NE PAS REGARDER DIRECTEMENT AVEC DES INSTRUMENTS OPTIQUES. (FRA) | RADIACION LASER DE CLASE 1M VISIBLE Y/O INVISIBLE CUANDO ESTA ABIERTO, NO MIRAR DIRECTAMENTE CON INSTRUMENTAL OPTICO. (SPA) | SYNLIG OCH/ELLER OSYNLIG LASERSTRALNING KLASS 1M, NÄR DENNA DEL ÄR ÖPPNAD. RETKIKOR EJ STRÄLEN MED OPTISKA INSTRUMENT. (SWE) | ここを覗くと有害 及び/または目や皮膚 のクラス1M レーザー放射が あります。 光学機器で直接 覗かないでください。 (JPN) | VISIBLE AND/OR INVISIBLE CLASS 1 LASER RADIATION WHEN OPEN, DO NOT STARE INTO BEAM. FDA 21 CFR (EN3) LV44608-008A |



Caution: Proper Ventilation

To avoid risk of electric shock and fire, and to prevent damage, locate the apparatus as follows:

1. Front: No obstructions and open spacing.
2. Sides/Top/Back: No obstructions should be placed in the areas shown by the dimensions below.
3. Bottom: Place on the level surface. Maintain an adequate air path for ventilation by placing on a stand with a height of 10 cm or more.

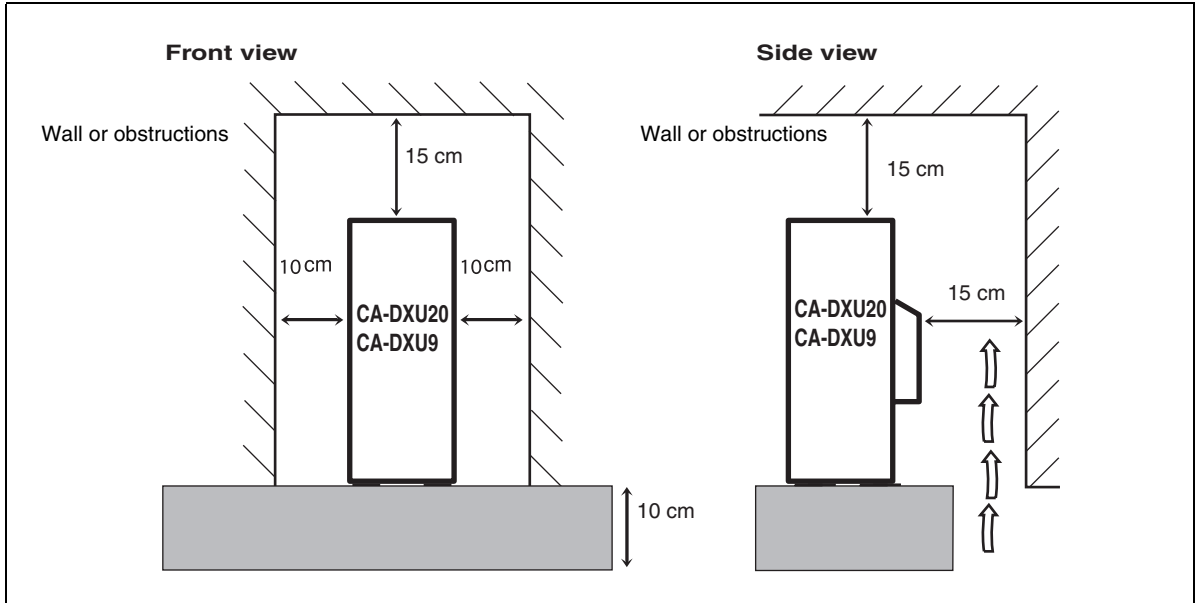

Introduction

Playable Disc/File Types

INFO



The “√” in the list below shows available disc/file types.

| Recording format | | Media type | | |
|------------------|---|----------------|-----------------------------|-------------------------------------|
| | | CD-R/ -RW*1 | DVD-R/ -RW, +R/ +RW*2 | USB mass storage class device |
| Discs | CD-DA (normal CD) | √ | — | — |
| | VCD/SVCD | √ | — | — |
| | DVD Video | — | √ | — |
| | DVD-VR | — | √*3 | — |
| AV files | Audio file: MP3/WMA/WAV | √ | √ | √ |
| | Video file: MPEG-1/MPEG-2/ ASF/DivX | √ | √ | √ |
| | Still picture file: JPEG | √ | √ | √ |

*1Recorded with “ISO 9660” format.

*2Recorded with “UDF-Bridge” format.

*3Not applicable for +R/+RW.

In addition to the above discs/files, this System can play back audio data recorded on CD-Extra and DVD/CD Text.

- This System can also play back DVD-ROM (DVD Video/MP3/WMA/WAV/JPEG/MPEG-1/MPEG-2/ASF/DivX format) and CD-ROM (MP3/WMA/WAV/JPEG/MPEG-1/MPEG-2/ASF/DivX format).
- The following discs cannot be played back: DVD-RAM, CD-I (CD-I Ready) and Photo CD. Playing back these discs will generate noise and damage the speakers.
- DVD Logo is a trademark of DVD Format/Logo Licensing Corporation.
- In this manual, “file” and “track” are interchangeably used for AV file operations.
- It is format to play back finalized +R/+RW (DVD Video format only) discs.

Caution for DualDisc playback:

The Non-DVD side of a “DualDisc” does not comply with the “Compact Disc Digital Audio” standard. Therefore, the use of Non-DVD side of a DualDisc on this product may not be recommended.

About color system

This System accommodates both NTSC and PAL system and can play back discs/files recorded in either system.

To change the color system, see page 6.

Note on Region Code

DVD players and DVD Video have their own Region Code numbers. This System can play back only DVD Video with an appropriate Region Code number.

- For details, see “Specifications” on page 54.

EX.: For Southeast Asia



Audio formats

The System can play back the following digital audio formats.

- **LPCM** (Linear PCM), **DIGITAL** (Dolby Digital), **DTS** (Digital Theater Systems), **MPEG Audio**
- Multi-channel audio of MPEG Audio will be downmixed into 2-channels. To enjoy multi-channel audio of MPEG Audio, connect an MPEG Audio decoder or an amplifier with a built-in MPEG Audio decoder to the OPTICAL DIGITAL OUTPUT terminal on the rear.

How to Read This Manual

- Button and control operations are explained in the table below.
- Some related tips and notes are explained later in the sections “Learning More about This System” and “Troubleshooting,” but not in the same section explaining the operations (**INFO** indicates that the content has some information).

| | |
|--|--|
| | Indicates that you press the button briefly . |
| | Indicates that you press the button briefly and repeatedly until an option you want is selected. |
| | Indicates that you press one of the buttons. |
| | Indicates that you press and hold the button for a specified period. The number inside the arrow indicates the period of a press (in the example, 2 seconds). |
| | Indicates that you turn the control toward the specified direction(s). |
| | Indicates that this operation is only possible using the remote control. |
| | Indicates that this operation is only possible using the main unit. |

Precautions

Installation

- Install the System in a location with adequate ventilation to prevent internal heat build-up in the System.



DO NOT install the System in a location near heat sources, or in a place subject to direct sunlight, excessive dust or vibration.

- Install in a place which is level, dry and neither too hot nor too cold—between 5°C and 35°C.
- Leave sufficient distance between the System and the TV.
- Keep the speakers away from the TV to avoid interference with the TV.

Power sources

- When unplugging the System from the wall outlet, always pull on the plug, not the AC power cord.



DO NOT handle the AC power cord with wet hands.

Moisture condensation

Moisture may condense in the lenses on the System in the following cases:

- After starting to heat the room
- In a damp room
- If the System is brought directly from a cold to a warm place.

Should this occur, the System may malfunction. In this case, leave the System turned on for a few hours until the moisture evaporates, unplug the AC power cord, then plug it in again.

Internal heat

- Make sure there is good ventilation around the System. Poor ventilation could overheat and damage the System. –A cooling fan is inside the System to prevent heat build-up.



DO NOT block the ventilation openings or holes. If they are blocked by a newspaper or cloth, etc., the heat may not be able to get out.

Others

- Should any metallic object or liquid fall into the System, unplug the AC power cord and consult your dealer before operating any further.



DO NOT disassemble the System since there are no user serviceable parts inside.

- If you are not going to operate the System for an extended period of time, unplug the AC power cord from the wall outlet.
- If anything goes wrong, unplug the AC power cord and consult your dealer.

Contents

| | |
|---|-----------|
| Connections | 3 |
| Connecting a USB Mass Storage Class Device..... | 6 |
| Preparing the Remote Control | 6 |
| Canceling the Demonstration | 6 |
| Changing the Color System and Scanning Mode | 6 |
| Display Indication | 7 |
| Daily Operations—Playback | 8 |
| Adjusting the Volume..... | 9 |
| Listening to the Radio..... | 9 |
| Playing Back a Disc/USB Mass Storage Class Device | 10 |
| Playing Back a Tape | 12 |
| Daily Operations—Sound & Other Adjustments | 13 |
| Adjusting the Speaker Output Level | 13 |
| Reinforcing the Bass Sound | 13 |
| Applying an Optimal Bass Sound Effect—VARIO BASS | 14 |
| Selecting the Sound Modes | 14 |
| Creating Your Own Sound Modes—User Mode | 14 |
| Selecting the Surround Modes..... | 15 |
| Presetting Automatic DVD Video Sound Increase Level | 15 |
| Changing the Picture Tone | 15 |
| Changing the Display Brightness | 16 |
| Setting the Clock | 16 |
| Unique Video Disc/File Operations | 17 |
| Selecting the Audio Track | 17 |
| Selecting the Subtitle Language | 18 |
| Selecting the View Angle | 18 |
| Reviewing the Playback Quickly | 18 |
| Special Picture Playback | 19 |
| Advanced Playback Operations | 20 |
| Programming the Playing Order—Program Play | 20 |
| Playing at Random—Random Play | 21 |
| Playing Repeatedly—Repeat Play | 22 |
| Prohibiting Disc Ejection—Child Lock | 22 |
| On-Screen Operations | 23 |
| On-screen Bar Information | 23 |
| Operations Using the On-screen Bar | 24 |
| Operations Using the Control Screen | 27 |
| Recording Operations | 29 |
| Recording from a CD onto a USB device | 30 |
| Recording onto a Tape..... | 31 |
| Dubbing Tapes..... | 31 |
| Synchronized Recording onto a Tape..... | 32 |
| Editing Operations | 33 |
| Giving (Editing) Titles to Tracks/Groups..... | 33 |
| Erasing Tracks or Groups | 36 |
| Enjoying Karaoke | 37 |
| Singing Along (Karaoke)..... | 37 |
| Adjusting the Sound Track for Karaoke..... | 38 |
| Scoring Your Karaoke Skill | 38 |
| Changing the Karaoke Setting..... | 39 |
| Reserving Karaoke Songs—Karaoke Program Play | 41 |
| Timer Operations | 42 |
| Setting the Timer | 42 |
| Turning Off the Power Automatically..... | 43 |
| Timer Priority | 43 |
| Setup Menu Operations | 44 |
| Operating the TV | 46 |
| Additional Information | 47 |
| Learning More about This System | 47 |
| Maintenance..... | 50 |
| Troubleshooting..... | 51 |
| Specifications..... | 54 |
| Parts Index | 55 |

Connections

Do not connect the AC power cord until all other connections have been made.

- Connect VIDEO OUT directly to the video input of your TV. Connecting VIDEO OUT to a TV via a VCR may interfere with your viewing when playing back a copy-protected source. Connecting VIDEO OUT to an integrated TV/VCR system may interfere with your viewing.

Supplied accessories

- FM antenna (x1)
 - AM loop antenna (x1)
 - Composite video cord (x1)
 - Remote control (x1)
 - Batteries (x2)
 - AC plug adapter (x1)
(not supplied for Australia and the Middle East)
- If any item is missing, consult your dealer immediately.

The illustration is CA-DXU20.

- ① **From the video input of TV/monitor**
See page 4.
- ② **From the digital input of digital audio component**
See page 4.
- ③ **From the analog audio output of auxiliary equipment (VCR, etc.)**
See page 4.
- ④ **From AM/FM antenna**
See page 4.
- ⑤ **From the speakers**
See page 5.
- ⑥ **Voltage selector (not applicable for Australian models)**
Before plugging in, confirm the position the voltage selector points at. See page 6.
- ⑦ **To a wall outlet**
Plug the AC power cord only after all connections are complete.
 - If the wall outlet does not match the AC plug, use the supplied AC plug adapter (not supplied for Australian and the Middle East models).

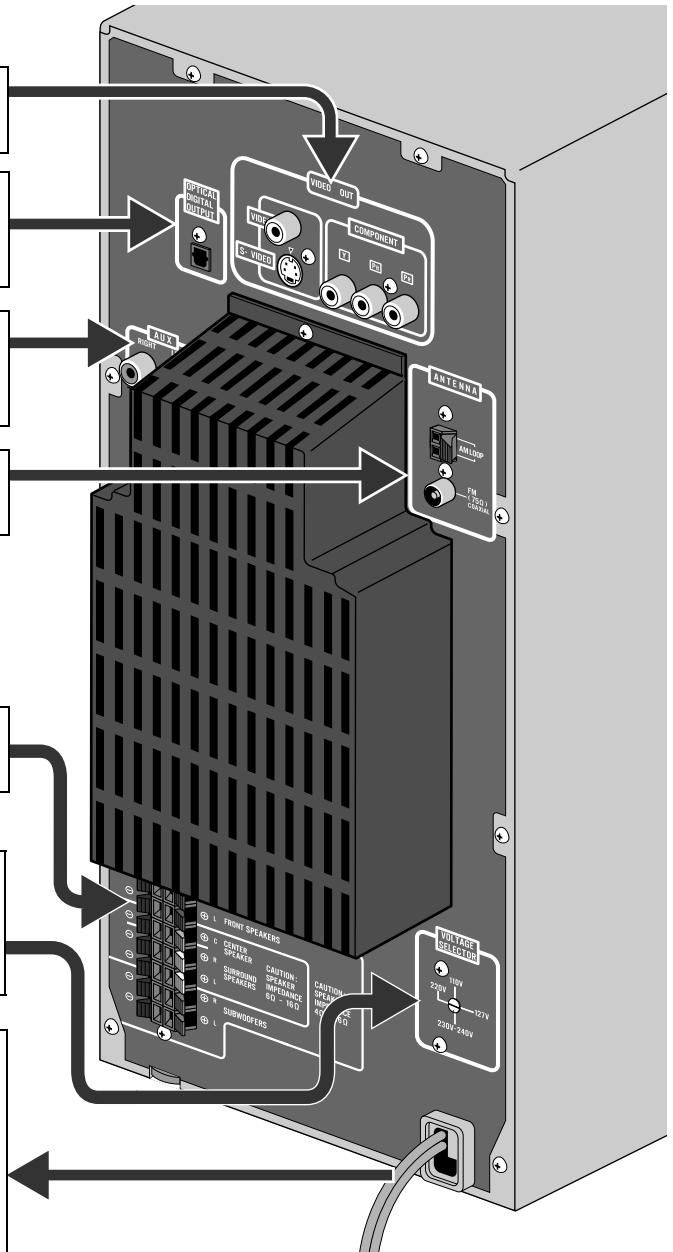

① TV/monitor

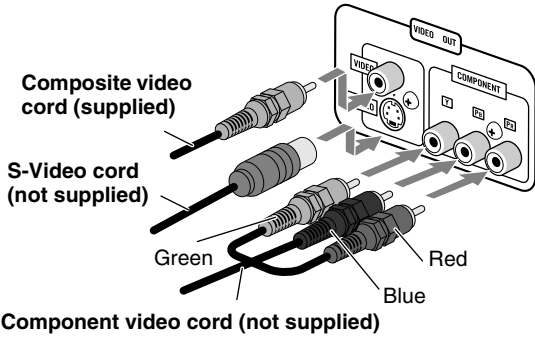

- To select progressive scanning mode (see page 6), use COMPONENT jacks.
- Connect the VIDEO jack, S-VIDEO jack, or COMPONENT jacks; whichever you want to use.
- You can get better picture quality in the order of— Composite video ⇒ S-video ⇒ Component video.

② Digital audio component

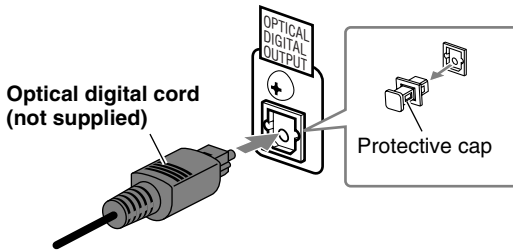

- Set “DIGITAL AUDIO OUTPUT” in the “AUDIO” menu correctly according to the connected digital audio equipment (see page 45).
- The digital signal through the OPTICAL DIGITAL OUTPUT terminal is transmitted only when the “DVD/CD” is selected as the source.

③ Auxiliary equipment

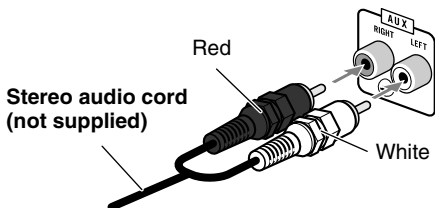

④ AM/FM antenna

To assemble the AM loop antenna

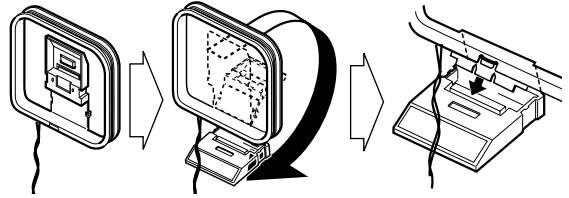

To connect AM/FM antenna

- If the antenna cord is covered with vinyl on the tip, twist and pull the vinyl off to remove.

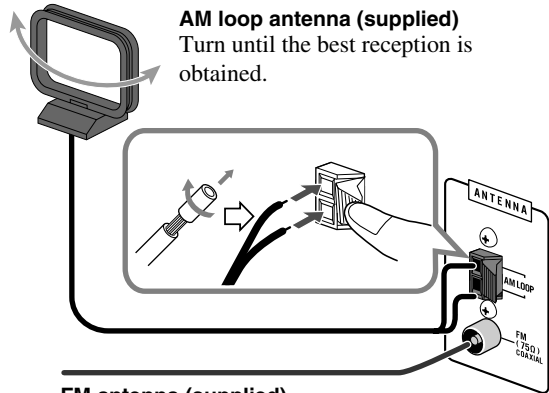

FM antenna (supplied)

Extend it so that you can obtain the best reception.

For better FM reception

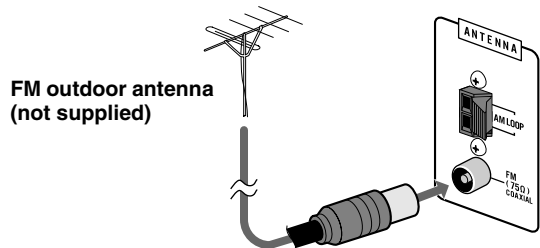

- Disconnect the supplied FM antenna, and connect an outdoor FM antenna using a 75 Ω wire with coaxial type connector (IEC or DIN45325).
- Make sure the antenna conductors do not touch any other terminals, connecting cords or the power cord. Also, keep the antennas away from metallic parts of the System, connecting cords, and the AC power cord. This could cause poor reception.

5 Speakers

To connect the speaker cords

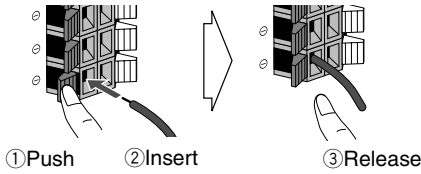

- When connecting the speaker cords, match their polarity with that of the speaker terminals: blue/red/green/white to (+) and black to (-).

For CA-DXU20

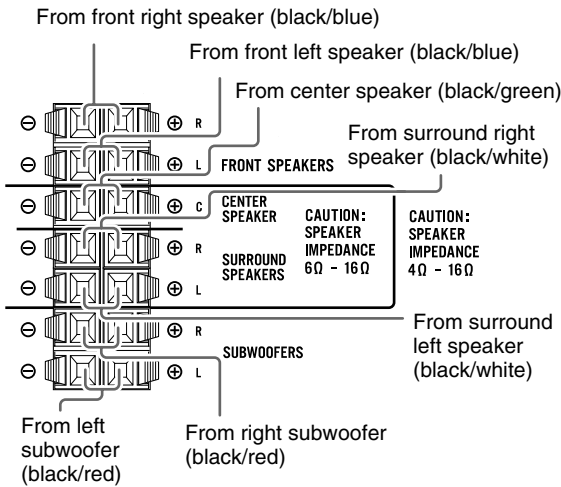

For CA-DXU9

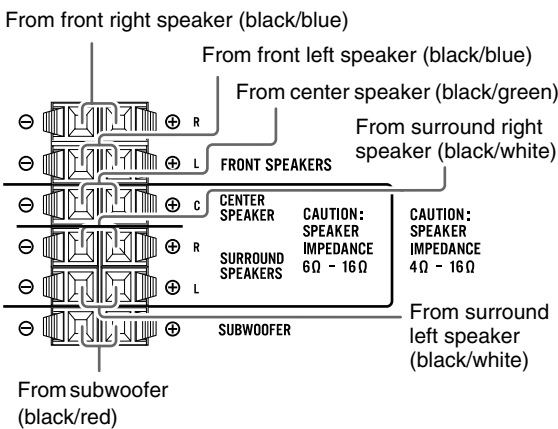

- Use only speakers with the same speaker impedance as indicated by the speaker terminals on the rear of the System.

- The front and center speakers and subwoofer(s) are magnetically shielded to avoid color distortions on TVs. However, if not installed properly, it may cause color distortions. So, pay attention to the following when installing the speakers.

- When placing the speakers near a TV set, turn off the TV's main power switch or unplug it before installing the speakers. Then wait at least 30 minutes before turning on the TV's main power switch again.

Some TVs may still be affected even though you have followed the above instruction. If this happens, move the speakers away from the TV.



- DO NOT connect more than one speaker to each terminal.
- DO NOT push or pull the speakers as this will damage the foot spacers at the bottom of the speakers.

Speaker layout

To enjoy multi-channel sound, locate the speakers as follows. If you cannot locate like this, adjust the speaker setting by using the SPK. SETTING menu (see page 45).

For CA-DXU20

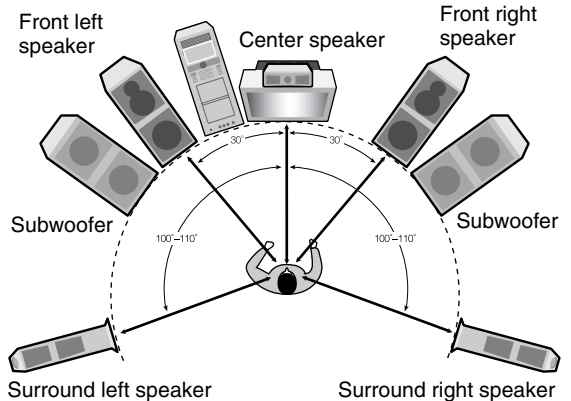

For CA-DXU9

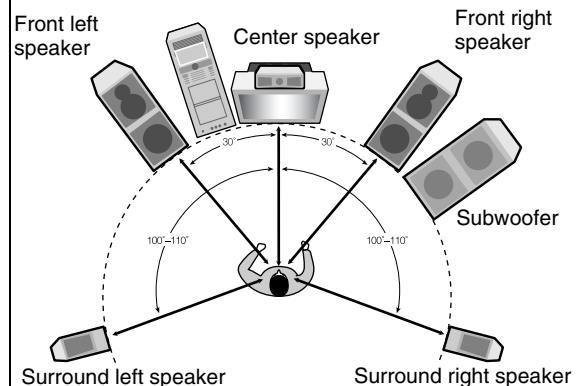

6 Voltage selector (not applicable for Australian models)

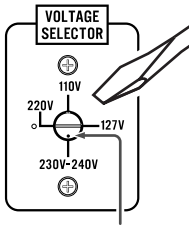

Voltage mark

Use a screwdriver to rotate the voltage selector so that the voltage mark is pointing to the same voltage as where you are plugging in the unit. (See also the back cover page.)

7 Power cord

Plug the AC power cord to a wall outlet.



DO NOT plug in before setting the voltage selector and all connection procedures are completed.

Connecting a USB Mass Storage Class Device

You can connect a USB mass storage class device such as a USB flash memory, hard disk drive, multimedia card reader, digital camera, etc. to this System.

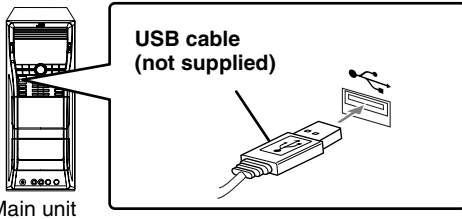

- When connecting with a USB cable, use the USB 2.0 cable whose length is less than 1 m.
- You cannot connect a computer to the (REC/PLAY) terminal of the System.

Preparing the Remote Control

Insert the battery into the remote control by matching the polarity (+ and -) correctly.

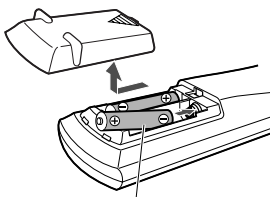

R6(SUM-3)/AA(15F)

When using the remote control, point the top of the remote control toward the remote sensor as directly as possible. If you operate it from a diagonal position, the operating range (approx. 5 m) may be shorter.

If the range or effectiveness of the remote control decreases, replace both batteries.

Caution: Be careful your children do not put the batteries into their mouth.

Canceling the Demonstration

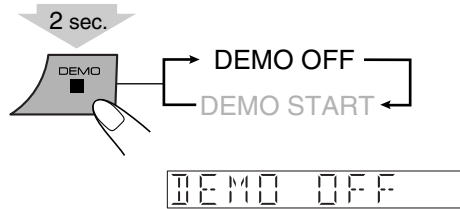

To start the demonstration, select DEMO START.

Changing the Color System and Scanning Mode



You can select the video output to match it to the color system of your TV (NTSC or PAL).

- If you connect a progressive TV through the COMPONENT jacks, you can enjoy a high quality picture by selecting progressive scanning mode.
- You can change the setting only while playback is stopped.

1 Enter the color system setting mode.

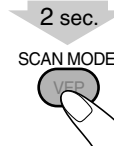

2 Select the color system and scanning mode.

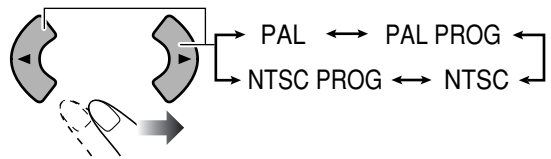

| | |
|--------------------------------|--|
| NTSC / PAL | NTSC or PAL Interlaced scanning. For a conventional PAL or NTSC TV. |
| NTSC PROG/ PAL PROG | NTSC or PAL Progressive scanning. For a progressive NTSC or PAL TV. |

3 Store the setting.



Display Indication

The indications on the display tell you a lot of things while you are operating the System. Before operating the System, be familiar with when and how the indicator illuminates on the display.

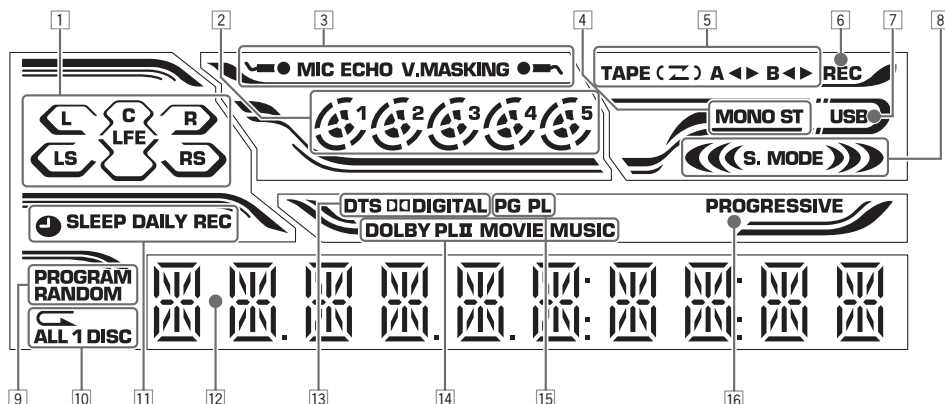

- 1 Audio signal indicators
 - L/R/C/LS/RS/LFE: lights to indicate the incoming audio channel signals.
 - : lights to indicate the speakers from which sound is emitted.
- 2 Disc indicators
 - 1 – 5: lights to indicate the current disc tray.
 - : lights when a disc is detected on the disc tray; rotates during playback or pause.
- 3 Karaoke operation indicators
 - / / : lights when Mic Mixing is activated; flashes when Karaoke Scoring is in use.
 - ECHO: lights when Echo is activated.
 - V.MASKING: lights when Vocal Masking is activated.
- 4 FM reception indicators
 - ST (stereo): lights while an FM stereo station with sufficient signal strength is tuned in.
 - MONO: lights while receiving an FM stereo station in monaural.
- 5 Tape operation indicators
 - TAPE: lights when a tape is loaded in either deck A or B.
 - (Reverse Mode): indicates the current Reverse Mode.
 - A: lights when a tape is in deck A.
 - B: lights when a tape is in deck B.
 - (tape direction):
 - Lights to indicate the current tape running direction.
 - Flashes slowly during playback and recording.
 - Flashes quickly while rewinding a tape.
- 6 REC indicator
 - Lights while recording.
- 7 USB indicator
 - Lights when “USB” is selected as the source.
- 8 Sound Mode/Surround mode indicators
 - S. MODE: lights when one of the Sound Mode is activated.
 - : lights when one of the Surround Mode is activated.
- 9 Play mode indicators
 - PROGRAM: lights when Program Play is activated.
 - RANDOM: lights when Random Play is activated.
- 10 Repeat mode indicators
 - : lights when Repeat Play is activated.
 - ALL: lights when All File Repeat is activated.
 - ALL DISC: lights when All Disc Repeat is activated.
 - 1 DISC: lights when One Disc Repeat is activated.
 - I: lights when One Track/Chapter/File/Step Repeat is activated.
- 11 Timer indicators
 - : lights when Daily Timer or Recording Timer is on standby, working, or being set.
 - SLEEP: lights when Sleep Timer is activated.
 - DAILY: lights when Daily Timer is on standby; flashes while working or being set.
 - REC: lights when Recording Timer is on standby; flashes while working or being set.
- 12 Main display
- 13 Source signal indicators
 - DTS: lights when DTS signals are detected.
 - DIGITAL: lights when Dolby Digital signals are detected.
- 14 Dolby Pro Logic II mode indicators
 - Lights when Dolby Pro Logic II (Movie or Music) is activated.
- 15 PG/PL indicator
 - PG: lights when Original Program is selected for DVD-VR playback.
 - PL: lights when Play List is selected for DVD-VR playback.
- 16 PROGRESSIVE indicator
 - Lights when the progressive scanning mode is selected.

Daily Operations—Playback

In this manual, the operations using the remote control are mainly explained; however, you can use the buttons and controls on the main unit if they have the same (or similar) name and marks.

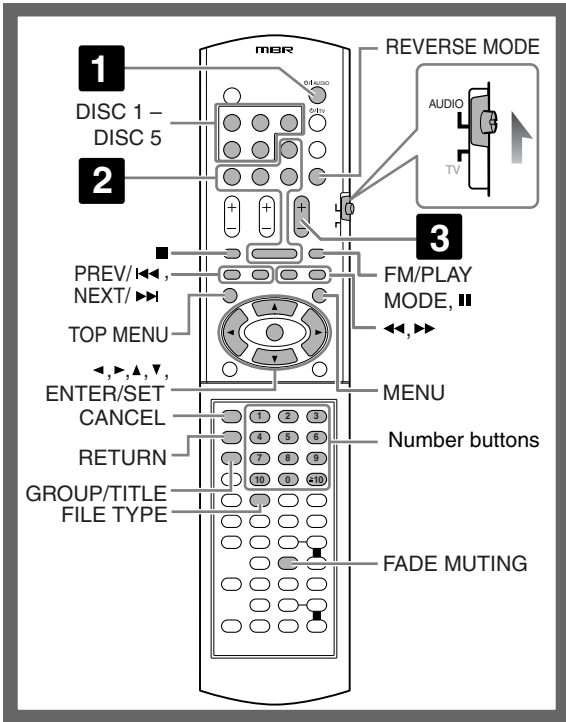

1 Turn on the power.

The STANDBY lamp on the main unit goes off.

- Without pressing ϕ /AUDIO, the System also turns on by pressing one of the source selecting buttons in the next step.

2 Select the source.

Playback automatically starts if the selected source is ready to start playback.

- To listen to the sound of the external component, press TUNER/AUX repeatedly to select "AUX" as the source, then start playback on the external component. (By pressing AUX on the main unit, you can also select "AUX" as the source.)

3 Adjust the volume.

To turn off (standby) the System



The STANDBY lamp on the main unit lights in red.

- A small amount of power is always consumed even while on standby.

For private listening

Connect a pair of headphones to the PHONES jack on the main unit. The sound will no longer come out of the speakers. **Be sure to turn down the volume before connecting or putting on the headphones.**

- Disconnecting the headphones will activate the speakers again.

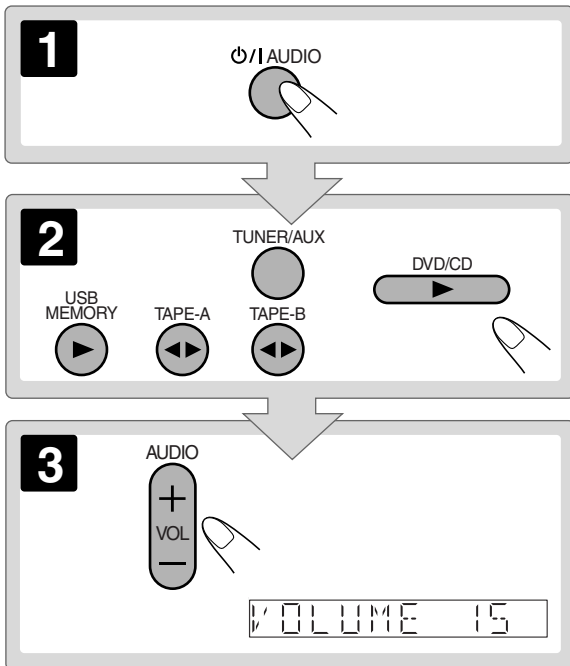

DO NOT turn off (standby) the System with the volume set to an extremely high level; otherwise, the sudden blast of sound can damage your hearing, speakers and/or headphones when you turn on the System or start playback.



How to select a number

| MARK | ABC | DEF |
|------|-----|-----|
| 1 | 2 | 3 |
| 4 | 5 | 6 |
| 7 | 8 | 9 |
| 10 | 0 | 10 |

To select 5, press 5.

To select 10, press 10.

To select 15, press \cong 10, 1, then 5.

To select 30, press \cong 10, 3, then 0.

To select 125, press \cong 10, \cong 10, 1, 2, then 5.

Adjusting the Volume

The volume level can be adjusted in 32 steps (VOLUME MIN, VOLUME 1 – VOLUME 30, and VOLUME MAX).

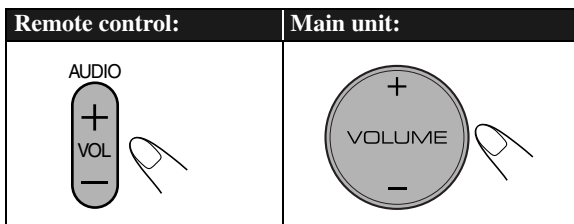

To drop the volume in a moment



To restore the volume, press again or adjust the volume level.

Listening to the Radio

To select the AM tuner interval spacing



Some countries space AM stations 9 kHz apart, and other countries use 10 kHz spacing.

1 Select “TUNER-AM,” then turn off (standby) the System.

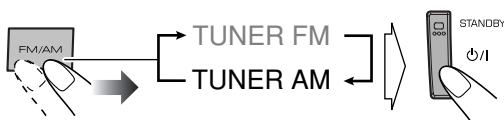

2 Select the AM tuner interval spacing.

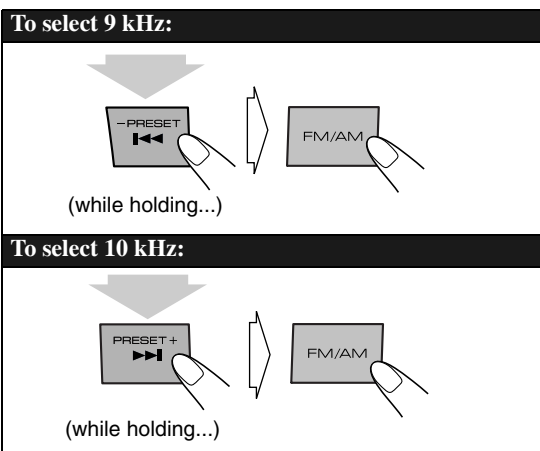

To select the band (FM/AM)

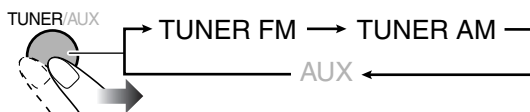

To tune in to a station

While FM or AM is selected...

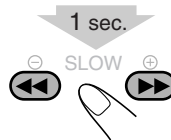

Frequency starts changing on the display. When a station (frequency) with sufficient signal strength is tuned in, the frequency search stops.

- When you repeatedly press the button, the frequency changes step by step.

To manually stop the searching, press either button.

If the FM reception is poor



The MONO indicator lights on the display. Reception will improve though stereo effect is lost—monaural reception mode.

To restore the stereo effect, press the button again (the MONO indicator goes off).

To preset stations

You can preset 30 FM and 15 AM stations.

1 Tune in to a station you want to preset.

- You can also store the monaural reception mode for FM preset stations if selected.

2 Activate the preset number entry mode.



- Finish the following process while the indication on the display is flashing.
- To cancel the operation during procedure, press CANCEL.

3 Select a preset number for the station you store.

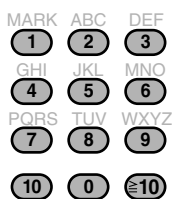

- To select a number, see “How to select a number” on page 8.

- You can also use ►►/◄◄ buttons.



4 Store the station.



To tune in to a preset station

1 Select the band (FM or AM).

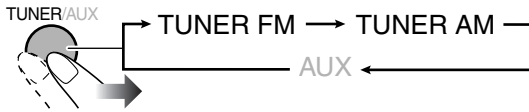

2 Select the preset number for the station you stored.

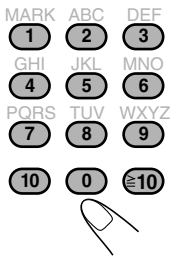

- To select a number, see “How to select a number” on page 8.
- You can also use ►►/◄◄ buttons.

Playing Back a Disc/USB Mass Storage Class Device

INFO

IMPORTANT: Before playing a disc/USB mass storage class device, make sure of the following...

- Turn on the TV and select an appropriate input mode on the TV to view the pictures or on-screen displays.
- For disc/USB mass storage class device playback, you can change the initial setting to your preference. See “Setup Menu Operations” on page 44.

If “⊘” appears on the TV screen when you press a button, the disc/USB mass storage class device cannot perform the operation you have tried to do.

- For playback of AV files, see also “Operations Using the Control Screen” on page 27.

To insert discs

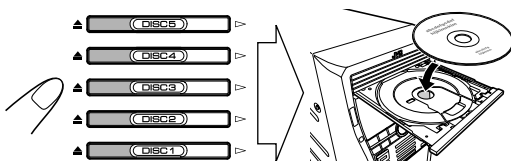

- When using an 8 cm disc, place it on the inner circle of the disc tray.

To close the disc tray, press the same ▲ button again.

- If you press ▷ for the same tray, the disc tray closes and playback starts automatically.

To connect a USB mass storage class device

- To connect a USB mass storage class device, see page 6.
- Always set volume level to the minimum level when connecting or disconnecting the USB mass storage class device.
- To disconnect the USB mass storage class device safely, turn off the System before disconnecting the device.

To play back disc/USB mass storage class device

| To start: | |
|--|--------------------------------------|
| <p>Disc</p> | <p>USB mass storage class device</p> |
| Playback starts. | |
| To pause: | |
| <p>FM/PLAY MODE</p> | |
| To release it, press DVD/CD ► or USB MEMORY ►. | |
| To stop: | |
| | |

While playing, this System can store the stop point (not applicable for CD). When you start playback again by pressing DVD/CD ► or USB MEMORY ►, it starts from the position where you have stopped—Resume Play. (“RESUME” appears when you stop playback.)

To stop completely while Resume is activated, press ■ twice. (To cancel Resume, see “RESUME” on page 45.)

On-screen guide icons

- During playback, the following icons may appear for a while on the TV screen:



Appears at the beginning of a scene containing multi-angle views.



Appears at the beginning of a scene containing multi-audio languages.



Appears at the beginning of a scene containing multi-subtitle languages.

- The following icons will also be shown on the TV screen to indicate your current operation.



- To deactivate the on-screen guide icons, see “ON SCREEN GUIDE” in “OTHERS” menu on page 45.

If different types of playable files (audio/still picture/video) are recorded, select a file type to play.

FILE TYPE



While playback is stopped...

- You can also select the file type using Setup Menu. See “FILE TYPE” in “PICTURE” menu on page 44.

To select a disc

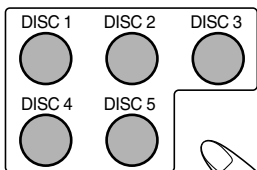

Playback starts.

To select a title/group

While playing...

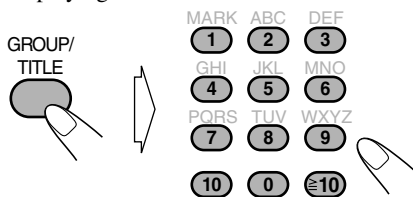

- To select a number, see “How to select a number” on page 8.

To select a chapter/track

While playing...

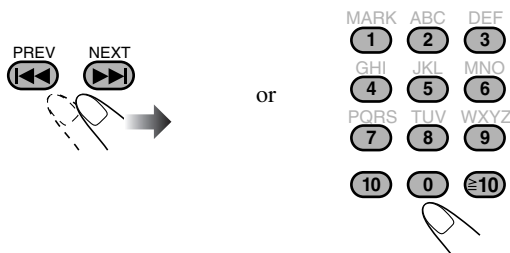

- The first time you press **PREV**, you will go back to the beginning of the current chapter/track.
- To select a number, see “How to select a number” on page 8.

To locate a particular portion

- This does not function for JPEG files.

While playing...

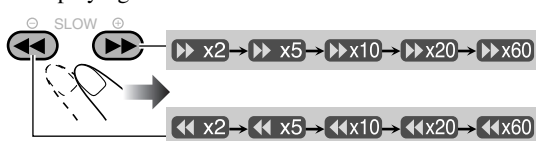

- Search speed changes as above for all discs/files except for MP3/WMA/WAV/DivX files. For MP3/WMA/WAV/DivX files, search speed is different.
- No sound comes out if searching is carried out while showing the moving picture.

To return to normal playback, press DVD/CD **▶** or USB MEMORY **▶**.

- For DivX files, each time you press the cursor **▶** or **◀**, you can skip to a scene of 30 seconds or 5 minutes away depending on the DivX file.

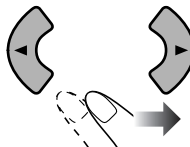

To select an item directly

You can select a title/chapter/track directly and start playback.

- For DVD Video, you can select a **title before starting playback**, while you can select a **chapter after starting playback**.

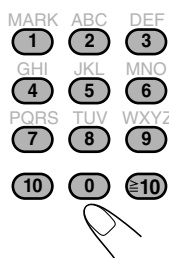

- To select a number, see “How to select a number” on page 8.

To play back by using the disc menu

You can operate the disc play using the disc menu.

■ For DVD Video

1 Show the disc menu.



2 Select an item on the disc menu.

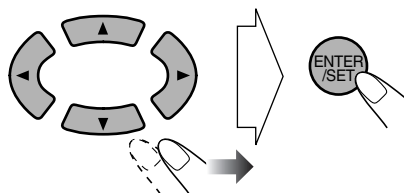

- On some discs, you can also select items by entering the number using the number buttons. To select a number, see “How to select a number” on page 8.

■ For SVCD/VCD with PBC

While playing a disc with PBC, "PBC" appears on the display instead of the playing time.

When disc menu appears on the TV screen, select an item on the menu. Playback of the selected item starts.

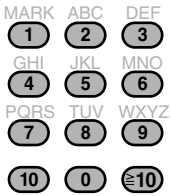

- To select a number, see "How to select a number" on page 8.

To move to the next or previous page of the current menu:



To return to the previous menu:

RETURN

To cancel PBC, press ■, then press ►►.

- You can also cancel PBC by pressing ■, then pressing the number buttons. Playback starts with the selected track.

To reactivate PBC, press ■, then press ◀◀.

Playing Back a Tape

To insert a tape

You can play back type I tapes.

- The use of C-120 or longer tape is not recommended.

Ex.: When using deck B.

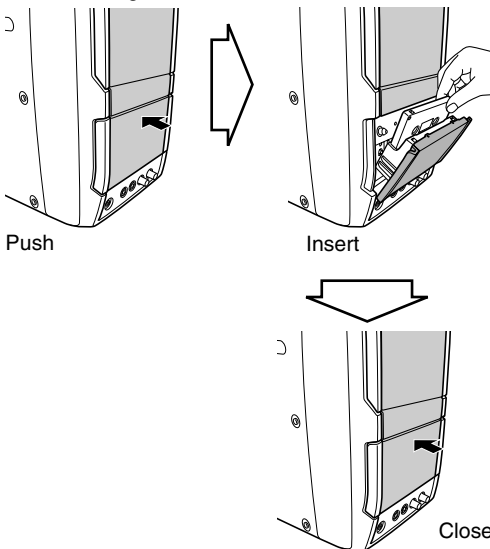

| | |
|--|-----------------|
| To start playback: | To stop: |
| | |
| To rewind or fast-forward tape: | |
| | |

To change the tape running direction

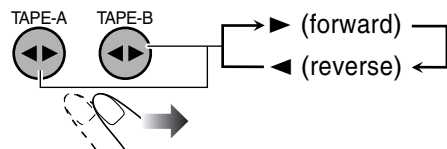

To reverse the tape automatically

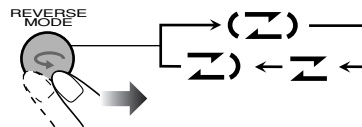

- (Z) Tape is reversed, and playback repeats until you stop it.
- Z Tape is not reversed. When the current side of the tape reaches its end, playback stops.
- Z) Tape is reversed once.

To play back both decks A and B continuously —Relay Play

When the cassettes are inserted in both decks...

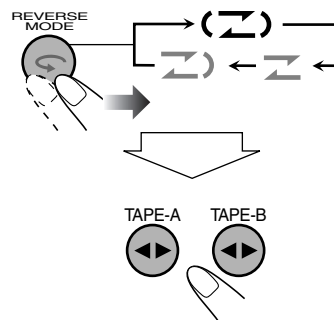

You can start playback with either deck A or B.

Daily Operations—Sound & Other Adjustments

Remote Control

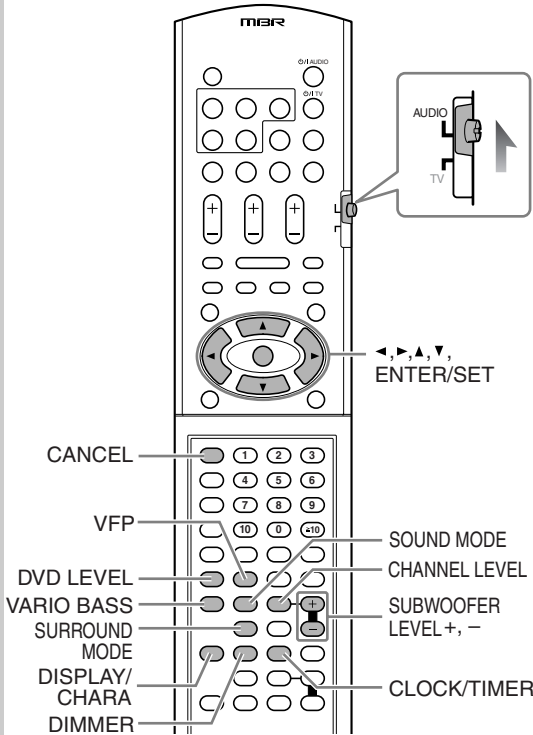

Main unit

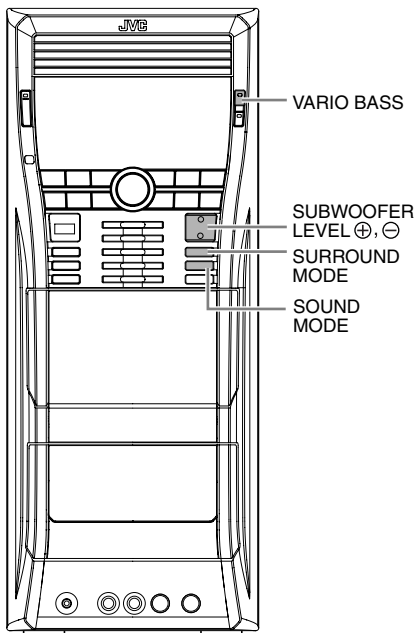

Adjusting the Speaker Output Level

Remote ONLY »»» INFO

You can adjust the speaker output level from -6 (dB) to $+6$ (dB). Initial setting: $+4$ (dB).

- You can also use the setup menu to adjust the speaker output level (see page 45).
- This function is not available when the surround mode is set to "STEREO" or Mic Mixing is activated.

1 Select the speaker you want to adjust.

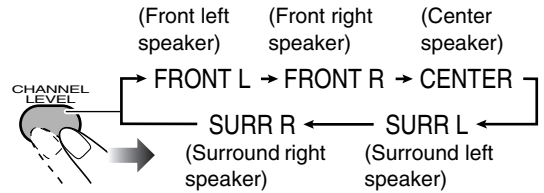

2 Adjust the output level while the display is showing speaker name.



3 Repeat steps 1 and 2 to adjust other speakers.

Reinforcing the Bass Sound

INFO

You can adjust the subwoofer level from level 1 (minimum) to level 5 (maximum).

Initial setting: 5

- This function is not available when the headphones are plugged in.



Applying an Optimal Bass Sound Effect

—VARIO BASS

You can adjust bass sound characteristics to create a sound suitable for the playback source of your preference.

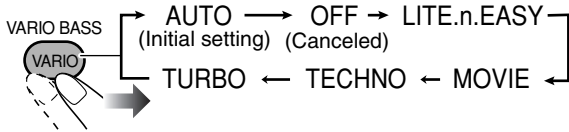

| | |
|--------------------|--|
| AUTO | The System automatically applies TURBO, LITE.n.EASY, MOVIE or TECHNO according to the playback source (initial setting). |
| LITE.n.EASY | Suitable for Karaoke and classical music. You can obtain a comfortable bass sound. |
| MOVIE | Suitable for a video source and playback of external component. You can obtain a strong bass sound. |
| TECHNO | Suitable for disco or techno music and playback of cassette tapes. You can obtain a strong bouncy bass sound. |
| TURBO | Suitable for most kinds of music and playback of external component. You can obtain a balanced bass sound. |

Selecting the Sound Modes

You can select one of the preset Sound Modes—SEA (Sound Effect Amplifier) mode.

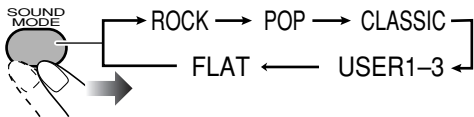

| | |
|------------------|---|
| ROCK | Boosts low and high frequency. Good for acoustic music (initial setting). |
| POP | Good for music with an emphasis on vocal. |
| CLASSIC | Good for classical music. |
| USER1/2/3 | Your individual mode stored in memory. See the next column “Creating Your Own Sound Modes—User Mode.” |

• While one of the Sound Mode is activated, S. MODE indicator lights up.

To cancel the Sound Mode, select “FLAT.”

Creating Your Own Sound Modes

—User Mode



You can adjust the preset Sound Modes to create your own Sound Modes which suit your taste. The changed settings can be stored as the USER1, USER2 and USER3 Modes.

While “USER1,” “USER2” or “USER3” is shown on the display...

1



2 Select the SEA parameter you want to adjust.

- ① BASS (Bass).
- ② MID (Mid-range).
- ③ TRE (Treble).

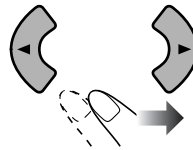

3 Adjust the parameter.

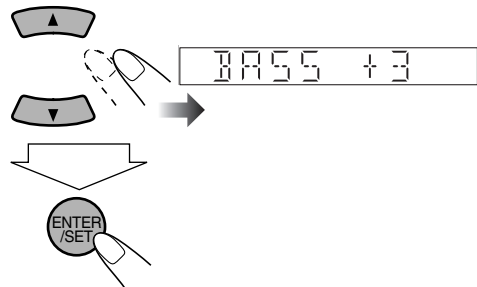

- You can adjust the level from -3 to +3.
- Repeat steps **2** and **3** to adjust other parameters.

4 Select one of the User Modes.

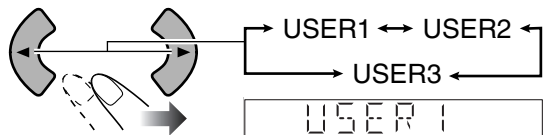

5 Store the setting.



- You can adjust the SEA pattern temporarily by doing the operations in steps **1** to **3**. The adjustment is cleared when you change the sound mode to another mode.

Selecting the Surround Modes INFO

- For “DVD/CD” and “USB” (multi-channel software):

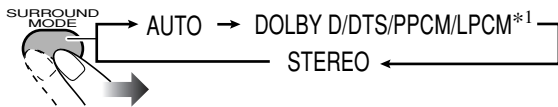

Initial setting: DOLBY D/DTS/PPCM/LPCM*1

- For “DVD/CD” and “USB” (stereo software), “TAPE” and “AUX”:

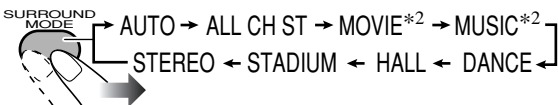

Initial setting: ALL CH ST

- For “TUNER AM” and “TUNER FM”:

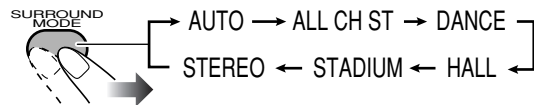

Initial setting: ALL CH ST

| DSP Modes | |
|--------------------------------|--|
| ALL CH ST | All Channel Stereo; Creates larger stereo sound field using all the connected speakers. |
| DANCE | Increases resonance and bass. |
| HALL | Adds depth and brilliance to the sound. |
| STADIUM | Adds clarity and spreads the sound, as in an outdoor stadium. |
| Stereo Mode | |
| STEREO | Cancels the Surround Mode. |
| Auto Surround Mode | |
| AUTO | The System automatically selects an appropriate Surround Mode or Stereo Mode according to the incoming signals. For example, a multi-channel source is automatically reproduced in an appropriate Multi-channel Surround Mode. |
| Multi-channel Surround Modes*1 | |
| DOLBY D | For multi-channel encoded Dolby Digital source. |
| DTS | For multi-channel encoded DTS source. |
| PPCM | For multi-channel encoded PPCM (Packed PCM) source. |
| LPCM | For multi-channel encoded LPCM (Linear PCM) source. |
| Dolby Pro Logic II Modes | |
| MOVIE | Creates 5.1-channel surround field from 2-channel source (suitable for movie source). |
| MUSIC | Creates 5.1-channel surround field from 2-channel source (suitable for music source). |

- While Surround Mode is activated, ◀◀◀ ▶▶▶ indicator lights up.

*1 Selectable Surround Mode varies depending on the software.

*2 MOVIE (Dolby Pro Logic II Movie) and MUSIC (Dolby Pro Logic II Music) cannot be used for DivX file.

Presetting Automatic DVD Video

Sound Increase Level Remote ONLY

The DVD Video sound is sometimes recorded at a lower level than other discs and sources. You can set the increase level for the currently loaded DVD Video, so you do not have to adjust the volume when you change the source.

- This function is available only for DVD Video discs.

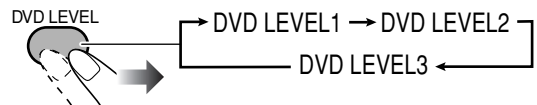

- As the number increases, sound level also increases.
- The initial setting is “DVD LEVEL3.”

Changing the Picture Tone Remote ONLY

While viewing a playback picture on the TV, you can select the preset picture tone, or adjust it and store your own preference.

To select a preset picture tone

- 1 While playing, display VFP setting screen.

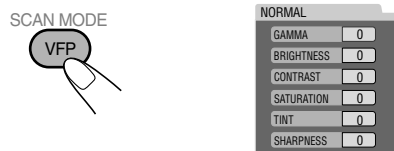

On the TV screen

- 2 Select a preset picture tone.

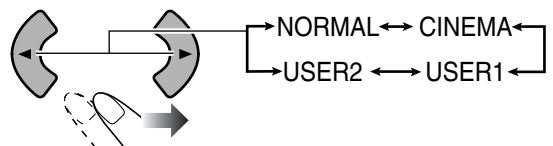

| | |
|--------------------|---|
| NORMAL | Normally select this. |
| CINEMA | Suitable for a movie source. |
| USER1/USER2 | You can adjust parameters and can store the settings (see next page). |

To adjust the picture tone

- 1 Select "USER1" or "USER2."
 - Follow steps 1 and 2 on page 15.
- 2 Select a parameter you want to adjust.

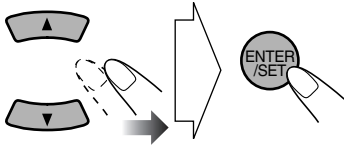

| | |
|-------------------|---|
| GAMMA | Adjust if the neutral color is bright or dark. The brightness of dark and bright portions is maintained (-3 to +3). |
| BRIGHTNESS | Adjust if the picture is bright or dark as a whole (-8 to +8). |
| CONTRAST | Adjust if the far and near position is unnatural (-7 to +7). |
| SATURATION | Adjust if the picture is whitish or blackish (-7 to +7). |
| TINT | Adjust if the human skin color is unnatural (-7 to +7). |
| SHARPNESS | Adjust if the picture is indistinct (-8 to +8). |

- 3 Adjust the parameter.

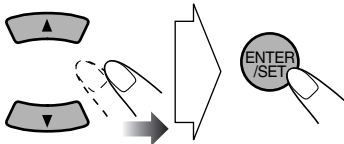

- 4 Repeat steps 2 to 3 to adjust other parameters.

To erase the VFP screen, press VFP again.

Changing the Display Brightness

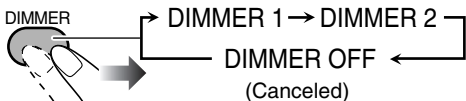

| | |
|-----------------|---|
| DIMMER 1 | Dims the display and the illumination* on the main unit. |
| DIMMER 2 | Dims the display (more than DIMMER 1) and turns off the illumination* on the main unit. |

* Excluding the KARAOKE SCORING lamp and VARIO BASS lamp (if they are in use).

Setting the Clock

Without setting the built-in clock, you cannot use any timers except the Sleep Timer.

- To exit from the clock setting, press CLOCK/TIMER as required.
- To correct a misentry during the process, press CANCEL. You can return to the previous step.

- 1 Activate clock setting mode.



- If you have already adjusted the clock before, press the button repeatedly until the clock time starts flashing.

- 2 Adjust the hour, then minute.

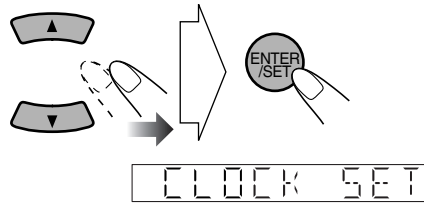

Now the built-in clock starts working.

To display the clock during playback

For "DVD/CD" and "USB":

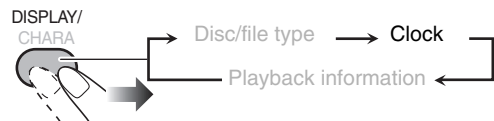

For "TAPE," "TUNER AM," "TUNER FM" and "AUX":

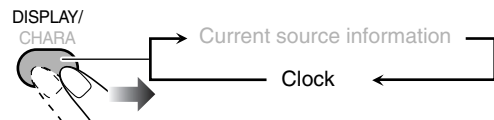

Unique Video Disc/File Operations

Remote Control

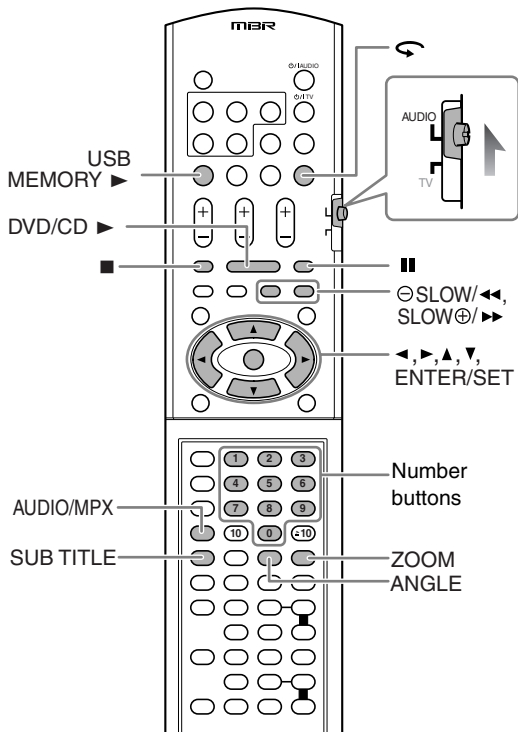

Selecting the Audio Track



For DVD Video/DivX: While playing back a chapter/file containing audio languages, you can select the language to listen to.

For DVD-VR/SVCD/VCD: While playing back a chapter/track, you can select the audio channel to play.

- You can also select the audio track using the on-screen bar (see page 24).



While playing DVD Video...

Ex.:

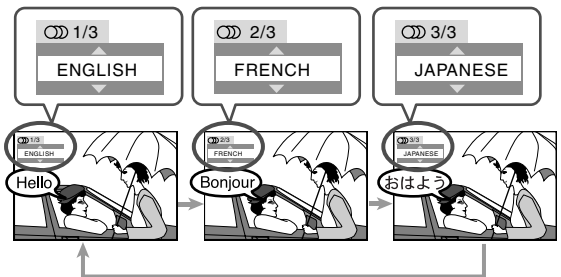

While playing a DivX...

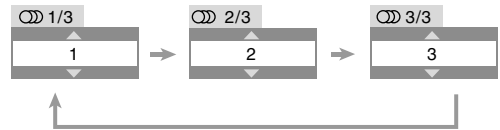

While playing a DVD-VR, SVCD or VCD...

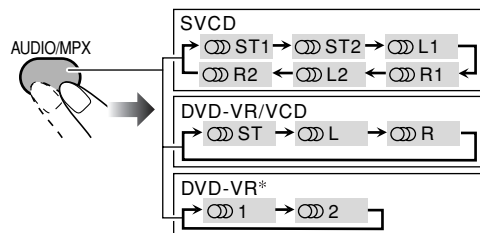

ST1/ST2/ST To listen to normal stereo (2-channel) playback.

L1/L2/L To listen to the left audio channel.

R1/R2/R To listen to the right audio channel.

* Example: When two multi-channel streams are recorded.

- SVCD can have 4 audio channels. SVCD usually uses these 4 channels to record two 2-channel recordings (ST1/ST2).

Selecting the Subtitle Language

For DVD Video/DivX: While playing back a chapter/file containing subtitles in different languages, you can select the subtitle language to display on the TV screen.

For DVD-VR: While playing, you can turn the subtitle on or off.

For SVCD: While playing, SUB TITLE button functions even if no subtitles are recorded on the disc.

- You can also select the subtitle language using the on-screen bar (see page 24).

While playing a DVD Video/DivX...

1 Display the subtitle selection window.

SUB TITLE



2 Select the subtitle language.

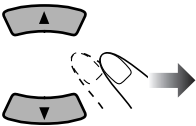

Ex.:

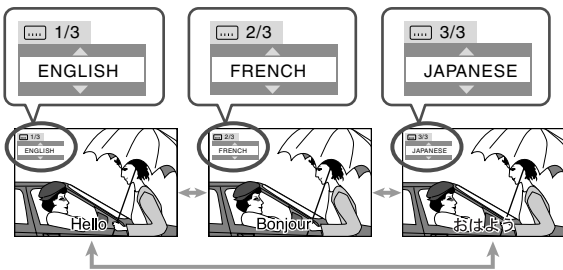

While playing a DVD-VR...

SUB TITLE

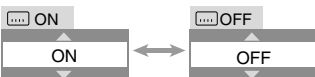

While playing an SVCD...

SUB TITLE

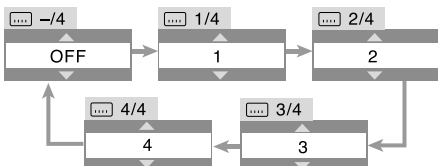

Selecting the View Angle

For DVD Video only: While playing back a chapter containing multi-view angles, you can view the same scene from different angles.

- You can also select the view angle using the on-screen bar (see page 24).

While playing...

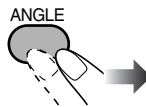

Ex.:

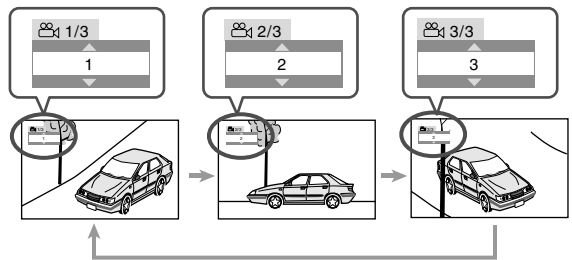

Reviewing the Playback Quickly

For DVD Video/DVD-VR only: You can move back the playback position by 10 seconds. (only within the same title)—Glance Back.

While playing...



Special Picture Playback

INFO

Pause playback

While playing...

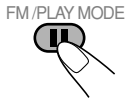

Playback pauses.

To resume normal playback, press DVD/CD ► or USB MEMORY ►.

Frame-by-frame playback

• This function is not available for ASF file.

1 While playing...



Still picture appears.

2 Advance the still picture frame by frame.



To resume normal playback, press DVD/CD ► or USB MEMORY ►.

Slow-motion playback

• This function is available only for DVD Video, DVD-VR, SVCD and VCD.

1 While playing...



Still picture appears.

2 Start slow-motion playback.

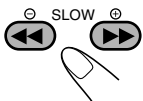

Speed changes as follows.



* Only for DVD Video.

To resume normal playback, press DVD/CD ►.

Zoom

• For JPEG/ASF files, see page 28.

While playing...

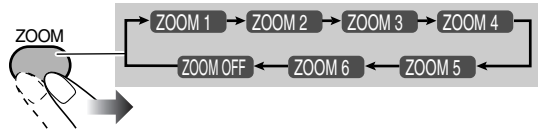

As the number increases, magnification also increases. You can move the zoomed-in area by pressing ◀/▶/▲/▼.

To cancel Zoom, press ZOOM repeatedly until “ZOOM OFF” appears on the TV screen.

Advanced Playback Operations

Remote Control

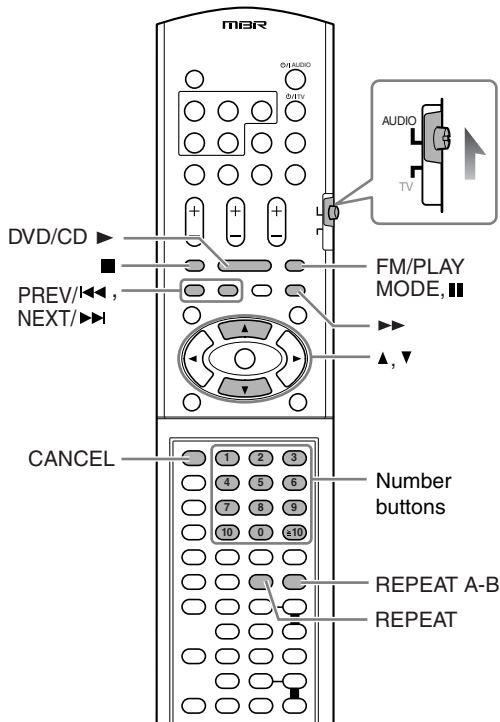

Main unit

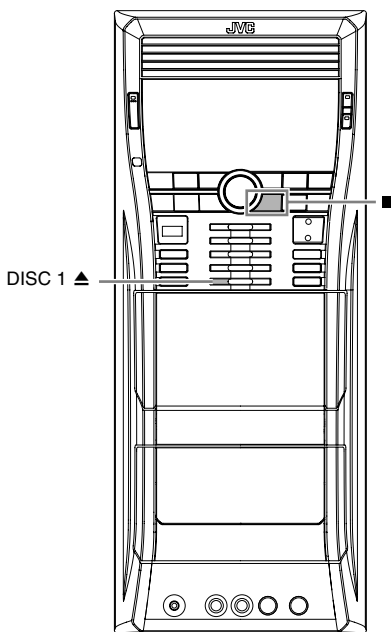

Programming the Playing Order

—Program Play



You can arrange the playing order of the chapters/tracks/files (up to 99) before you start playback.

- Program Play cannot be used for files in a USB mass storage class device, Video files/JPEG files on a disc and DVD-VR.

1 Before starting playback, activate Program Play.

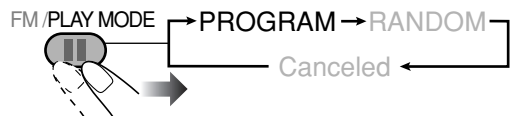

PROGRAM

On the display

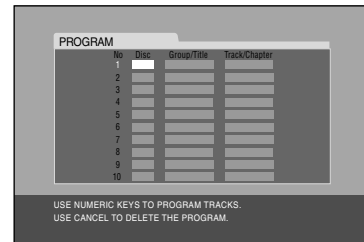

On the TV screen

2 Select chapters/tracks/files you want for Program Play.

- ① Select a disc number.
- ② For DVDs and Audio files: Select a group/title number.
- ③ Select a track/chapter number.

- To select a number, see “How to select a number” on page 8.

3 Repeat step 2 above until you complete your program.

4 Start playback.

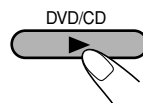

Playback starts in the order you have programmed.

| To skip: | To pause: | To stop*: |
|----------|------------------------------------|-----------|
| | <p>To release, press DVD/CD ►.</p> | |

* Resume does not work for Program Play.

To check the programmed contents

Before or after playback...

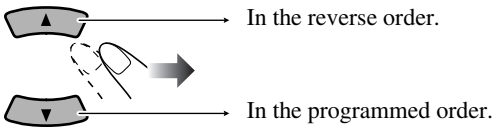

To modify the program

Before or after playback...

| To erase the last step: | To erase the entire program: |
|--|------------------------------|
| | |
| To add steps in the program: Repeat step 2 on page 20. | |

To exit from Program Play

Before or after playback...

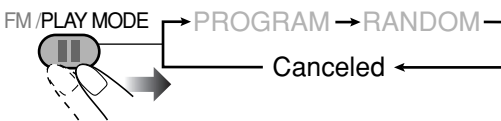

Playing at Random—Random Play

You can play the contents of all the loaded discs at random.

- Random Play cannot be used for files in a USB mass storage class device, Video files/JPEG file on a disc, DVD-VR and some DVDs.

1 Before starting playback, activate Random Play.

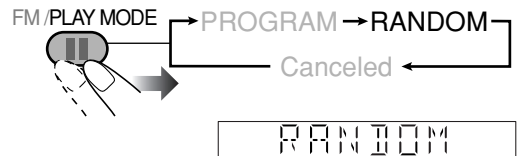

2 Start playback.

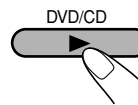

Playback of the current disc starts in a random order. When all chapters/tracks on the current disc are played, playback of the next disc starts. Random Play ends when all loaded discs are played.

| To skip: | To pause: | To stop: |
|---|------------------------------------|----------|
| <p>To go to the beginning of the current chapter/track, press ◀◀.</p> | <p>To release, press DVD/CD ►.</p> | |

To exit from Random Play

Before or after playback...



Playing Repeatedly—Repeat Play

You can repeat playback.

- You can also select the repeat mode using the on-screen bar (see page 23. Not applicable for AV files and JPEG file.)
- For Video file/JPEG file and DVD-VR, see page 28.
- The indicator(s) lights on the display as follows to indicate the current repeat mode.

Repeat Play

• For DVD Video:

While playing...

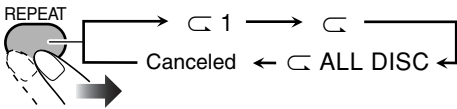

• For Audio files (MP3/WMA/WAV):

While playing or before playback...

- When repeating Audio files on disc:

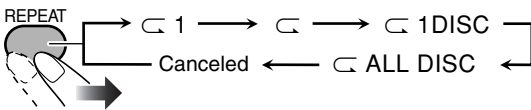

- When repeating Audio files in a USB mass storage class device:

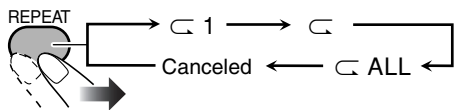

• For CD/SVCD/VCD:

While playing or before playback (without PBC for SVCD/VCD)...

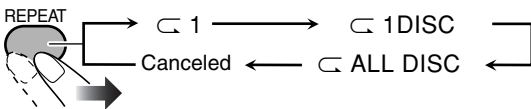

• For Random Play:



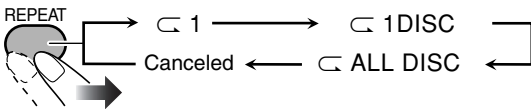

While playing or before playback...

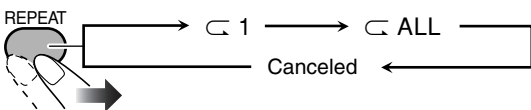

• For Program Play:

While playing or before playback...



| | |
|---|---|
|  1 | Repeats the current chapter/track/file/step. |
|  | Repeats the current title/group/program. |
|  1 DISC* | Repeats the current disc. |
|  ALL DISC* | Repeats all discs. |
|  ALL | Repeats all files in a USB mass storage class device or all programmed chapters/tracks/files. |

*These modes may not work correctly for DVDs.

A-B Repeat

You can repeat playback of a desired portion by specifying the beginning (point A) and the ending (point B).

- A-B Repeat cannot be used for AV files and some DVDs.

1 While playing (without PBC for SVCD/VCD), select the start point (A).

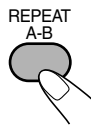

2 Select the end point (B).



- You can search for the end point using the ►► button.

To cancel A-B Repeat, press REPEAT A-B again.

- A-B Repeat will also be canceled when you stop play or skip the chapter or track.

Prohibiting Disc Ejection—Child Lock

You can lock the disc trays so that no one can eject the loaded discs.

While on standby...

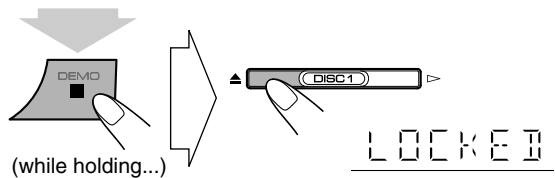

To cancel the prohibition, repeat the same procedure. "UNLOCKED" appears on the display.

On-Screen Operations

Remote control

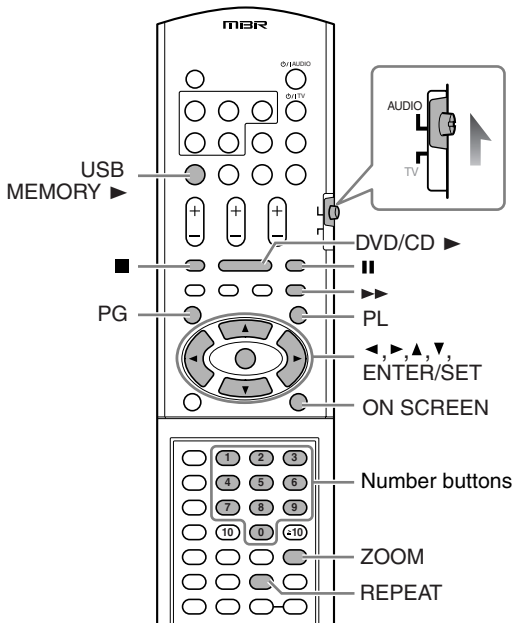

On-screen Bar Information

You can check the playback information and use some functions through the on-screen bar. (Not applicable for Audio file and JPEG file.)

On-screen bars

DVD Video

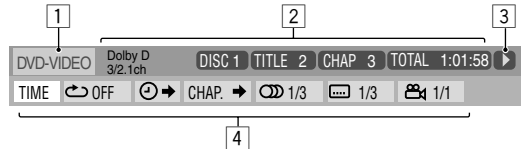

DVD-VR

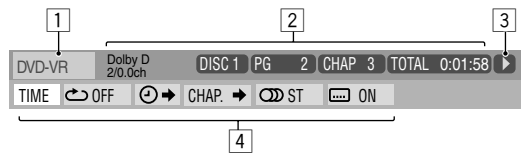

SVCD

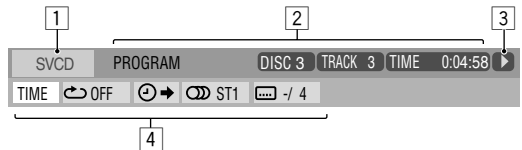

VCD

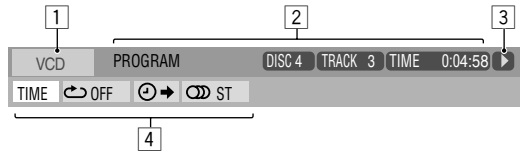

CD

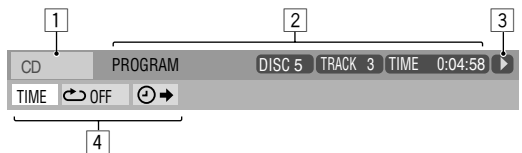

Video file on a disc—MPEG-1/MPEG-2/ASF/DivX



Video file in a USB mass storage class device—MPEG-1/MPEG-2/ASF/DivX



1 Disc type/source type

2 Playback information

| Indication | Meanings |
|---------------------------|-------------------|
| Dolby D/DTS/ PPCM/LPCM | Audio format |
| 3/2.1 ch/ 2/0.0 ch | Channel number |
| PROGRAM/ RANDOM | Current play mode |
| DISC 1 | Current disc |
| TITLE 2 | Current title |
| CHAP 3 | Current chapter |
| GROUP 1 | Current group |
| TRACK 14 | Current track |
| PG 2 | Current program |
| PL 2 | Current playlist |
| TOTAL 1:25:58 | Time indications |

3 Playback conditions

| Indication | Meanings |
|------------|-----------------------------|
| ▶ | Playback |
| ▶▶ / ◀◀ | Forward/Reverse search |
| ▶▶ / ◀◀ | Forward/Reverse slow-motion |
| ⏸ | Pause |
| ■ | Stop |

4 Operation icons (on the pull-down menu)

| Indication | Meanings |
|------------|--|
| TIME | Select to change the time indication (see also page 25). |
| ↺ | Select to repeat playback (see also page 25). |
| ⌚ → | Select for time search (see also page 26). |
| CHAP. → | Select for chapter search (see also page 26). |
| TRACK → | Select for track search (see also page 26). |
| 🔊 1/3 | Select to change the audio language or channel (see also page 17). |
| 🗣️ 1/3 | Select to change subtitle language (see also page 18). |
| 📺 1/3 | Select to change view angle (see also page 18). |

5 Repeat play setting for Video files (See also page 28.)

Operations Using the

On-screen Bar



Basic operation procedures through the on-screen bar are as follows:

Ex.: Selecting a subtitle (French) for DVD Video:

While a disc is selected as the source...

1 Display the on-screen bar with the pull-down menu.

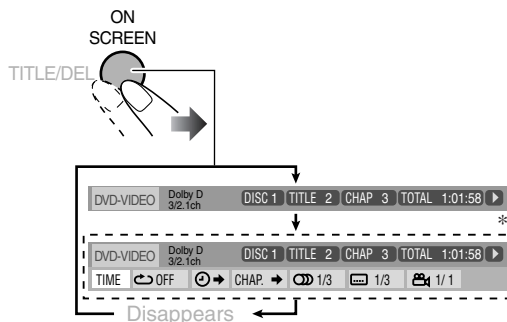

*This does not appear for Video files.

2 Select (highlight) the item you want.

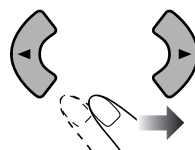

3 Display the pop-up window.



4 Select the desired option in the pop-up window.

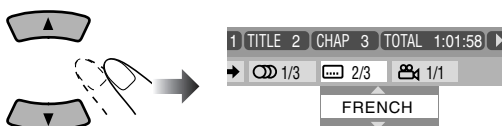

5 Finish the setting.

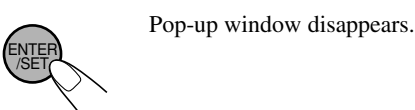

Pop-up window disappears.

To erase the on-screen bar, press ON SCREEN again.

To change the time information

You can change the time information in the on-screen bar and the display window on the main unit.

1 Display the on-screen bar with the pull-down menu.



2 Make sure **TIME** is selected (highlighted).

3 Change the time indication.



| | |
|---------------|--|
| TOTAL | Elapsed disc time. |
| T. REM | Remaining time of the current disc/title. |
| TIME* | Elapsed playing time of the current chapter/track. |
| REM* | Remaining time of the current chapter/track. |

* Not applicable for DVD-VR.

Repeat Play

- For Audio files, see also page 22.
- For Video files and JPEG file, see page 28.

1 While playing a disc (without PBC for SVCD/VCD), display the on-screen bar with the pull-down menu.

- All discs except DVD: Repeat Play can be selected before starting playback.

2 Select .

3 Display the pop-up window.



4 Select the repeat mode you want.

| | |
|----------------|---|
| ALL | Repeats all discs or all programmed tracks. |
| A-B | Repeats a desired portion (see below). |
| TITLE | Repeats the current title. |
| GROUP | Repeats the current group. |
| DISC | Repeats the disc (except for DVD). |
| CHAPTER | Repeats the current chapter. |
| TRACK* | Repeats the current track. |
| PG | Repeats the current program (for DVD-VR only). See also page 28. |
| PL | Repeats the current playlist (for DVD-VR only). See also page 28. |
| OFF | Cancels Repeat Play. |

* During Program Play or Random Play, "STEP" appears.

5 Finish the setting.



Pop-up window disappears.

A-B Repeat

1 While playing a disc, display the on-screen bar with the pull-down menu.

2 Select .

3 Display the pop-up window.



4 Select "A-B."

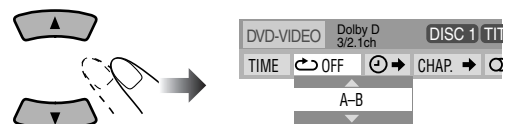

5 Select the start point (A).



- After selecting the starting point (A), you can search for the end point using .

6 Select the end point (B).



A-B Repeat starts. The selected portion plays repeatedly.

To cancel A-B Repeat, repeat steps 1 to 3, and select “OFF” in step 4.

Time Search

You can move to a particular point by specifying the elapsed playing time from the beginning.

1 While playing a disc (without PBC for SVCD/VCD), display the on-screen bar with the pull-down menu.

- All disc except DVD: Time Search can be used before starting playback.

2 Select [ENTER/SET].

3 Display the pop-up window.



4 Enter the time.

You can specify the time in hours/minutes/seconds.

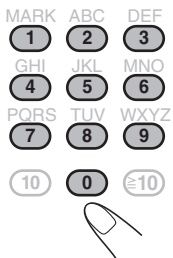

Examples:

To move to a point of 1 (hours): 02 (minutes): 00 (seconds), press 1, 0, 2, 0, then 0.

To move to a point of 54 (minutes): 00 (seconds), press 0, 5, 4, 0, then 0.

- It is always required to enter the hour digit (even “0” hour), but it is not required to enter trailing zeros (the last two digits in the examples above).
- To correct a misentry, press cursor ◀ to erase the last entry.

5 Finish the setting.



The System starts playing from the specified time.

Chapter/Track Search

You can search for the number of the item to play. For DVD Video/DVD-VR: Chapter

1 While playing a disc, display the on-screen bar with the pull-down menu.

2 Select [CHAP.] or [TRACK].

3 Display the pop-up window.



4 Enter the desired chapter/track number.



Examples:

To select 5, press 5.

To select 15, press 1, then 5.

To select 30, press 3, then 0.

- To correct a misentry, press the number buttons until the desired number is shown in the pop-up window.

5 Finish the setting.



The System starts playing the searched chapter or track.

Operations Using the Control Screen

For DVD-VR, AV files and JPEG files: You can search for and play the desired items through the control screen.

Control screen for DVD-VR

The control screen is superimposed on the TV screen when you call up Original Program (PG) or Play List (PL) screens.

To select playback type

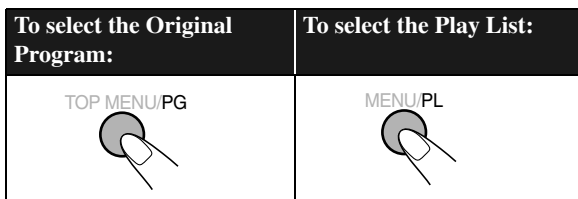

When Original Program screen is superimposed.

| No | Date | Ch | Time | Title |
|----|----------|-----|-------|--------------------|
| 1 | 25/12/08 | 4ch | 19:00 | JVC DVD World 2004 |
| 2 | 17/01/09 | 8ch | 10:30 | |
| 3 | 22/01/09 | 8ch | 17:00 | Music Festival |
| 4 | 26/02/09 | L-1 | 13:19 | children 001 |
| 5 | 20/02/09 | 4ch | 22:00 | |
| 6 | 25/02/09 | L-1 | 8:23 | children 002 |

When Play List screen is superimposed.

| No | Date | Chap | Length | Title |
|----|----------|------|---------|-----------------|
| 1 | 25/01/09 | 001 | 1:03:16 | My JVC World |
| 2 | 17/02/09 | 005 | 1:35:25 | |
| 3 | 20/02/09 | 003 | 0:10:23 | Favorite music |
| 4 | 25/02/09 | 001 | 0:07:19 | children001-002 |

- ① Program/Play list number
- ② Recording date
- ③ Recording source (TV station, the input terminal of the recording equipment, etc.)
- ④ Start time of recording
- ⑤ Title of the program/play list*
- ⑥ Highlight bar (current selection)
- ⑦ Creating date of play lists
- ⑧ Number of chapters
- ⑨ Playback time

* The title of the original program or play list may not be displayed depending on the recording equipment.

To remove the control screen, press ENTER/SET.

Control screen for AV files/JPEG files

The control screen automatically appears on the TV screen when the System detects Audio files on the loaded disc or connected USB mass storage class device. (For Video files/JPEG file, it appears when playback is stopped.)

Ex.: While playing an MP3 file on a disc.

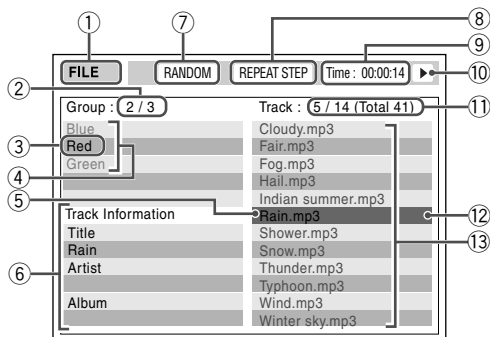

- ① Current source
FILE: Current source is "DVD/CD".
USB: Current source is "USB".
- ② Current group number/total group number
- ③ Current group
- ④ Group list
- ⑤ Current file
- ⑥ File information (only for MP3/WMA/WAV file)
- ⑦ Play mode information. (RANDOM or PROGRAM. Not applicable for USB mass storage class device.)
- ⑧ Repeat Play setting
- ⑨ Elapsed playing time of the current file (not applicable for JPEG file)
- ⑩ Operation status icon
- ⑪ Current file number/total number of files in the current group (total number of files on the current disc/USB mass storage class device)
- ⑫ Highlight bar (current selection)
- ⑬ File list

• If different types of files (Audio files, Video files and Still picture files) are recorded on a disc/USB mass storage class device, select the file type to play (see page 44).

To move the highlight bar between group list and file list:

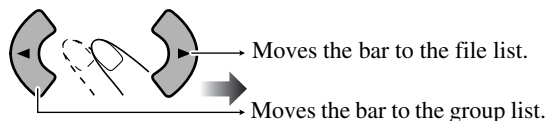



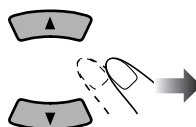

To select an item in the list:

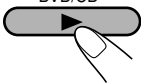

Move the highlight bar to the desired item.

- If you move the highlight bar while playing back DVD-VR or Audio files, the selected item starts playback automatically.

To start playback

| For JPEG file: | |
|---|--|
|  | The selected file (still picture) is displayed until you change it. |
| Disc  USB mass storage class device  | Slide-show playback starts. Each file (still picture) is shown on the screen for a few seconds, then changes one after another. • To cancel slide-show for JPEG file, and display the current still picture, press II . |
| For the other: | |
|  | Playback starts with the selected chapter/file. • Pressing DVD/CD  or USB MEMORY  also starts playback. |

- Once you start viewing a JPEG file or Video file, the control screen disappears.

To stop playback

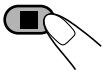

To repeat chapter/program/play list for DVD-VR



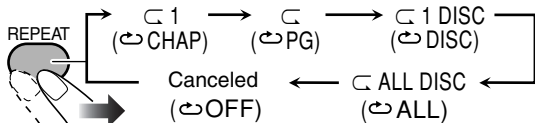

While playing or before starting playback...

For Original Program

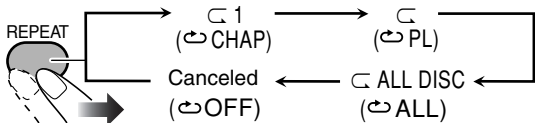

For Play List



| | |
|--|---|
|  1* | Repeats the current chapter. |
|  * | Repeats the current program/play list. |
|  1 DISC* | Repeats all programs on the current disc. |
|  ALL | Repeats all loaded discs. |

*Not available before starting playback.

To repeat slide-show for JPEG file

While playing or before starting playback...

- When repeating JPEG file on disc:

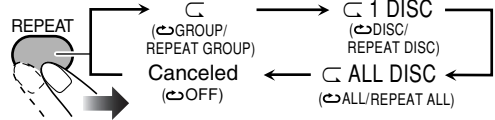

- When repeating JPEG file in a USB mass storage class device:

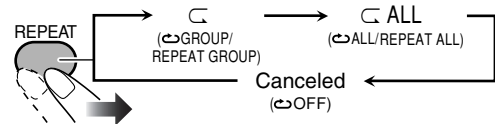

To repeat play for Video files



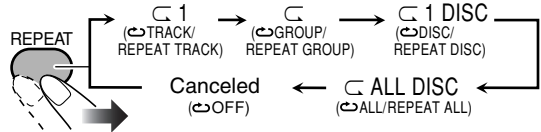

While playing or before starting playback...

- When repeating Video file on disc:

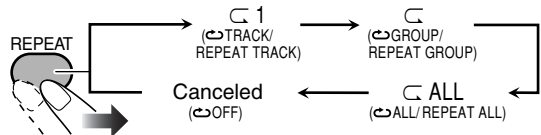

- When repeating Video file in a USB mass storage class device:



| | |
|---|--|
|  1 | Repeats the current file. |
|  | Repeats the current group. |
|  ALL | Repeat all files in the USB mass storage class device. |
|  1 DISC | Repeats all files on the current disc. |
|  ALL DISC | Repeats all loaded discs. |

- For Repeat Play of Audio file, see page 22.

To zoom in the JPEG/ASF file

While playing...

- If playing back JPEG file with slide-show, press **II** to display the still picture, then...

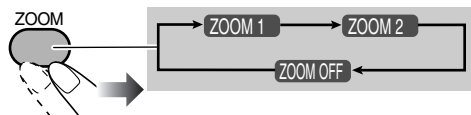

As the number increases, magnification increases.

- You can move the zoomed-in area by pressing **◀/▶/▲/▼**.

To cancel Zoom, press ZOOM repeatedly until “ZOOM OFF” appears on the TV screen.

Recording Operations

Remote control

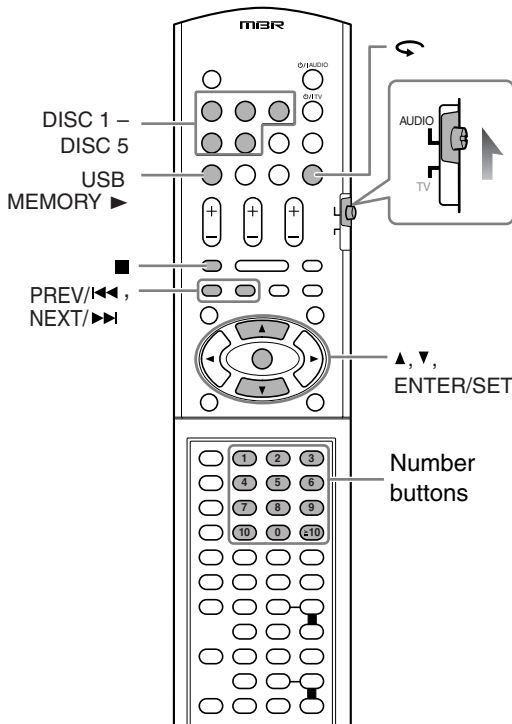

Main unit

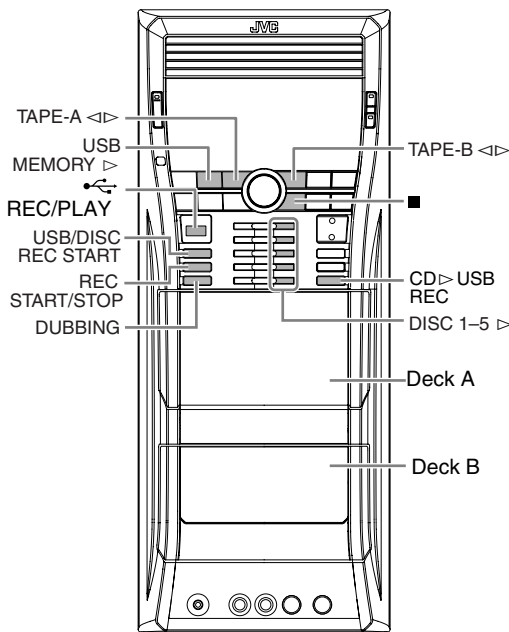

You can record following sources onto a USB mass storage class device or Type I tape.

| Device to record onto: | Recordable source: |
|-------------------------------|--------------------------------|
| USB mass storage class device | Audio CD |
| Type I tape | FM/AM, DVD, CD, USB, TAPE, AUX |

IMPORTANT

It should be noted that it may be unlawful to re-record pre-recorded tapes, records, or discs without the consent of the owner of copyright in the sound or video recording, broadcast or cable program and in any literary, dramatic, musical, or artistic work embodied therein.

- The channel level setting (see page 13 and 45) affects the Tape recording only.
- The recording level is not affected by the volume.
- Bass sound effect (VARIO BASS) and sound mode effect (see page 14) do not affect recordings.
- Random Play and Repeat mode are cancelled in the recording mode.
- You can record up to 999 tracks to the USB device. If you try to record a track after recording 999 tracks, “TRACK FULL” appears on the display and the track will not be recorded.
- The tracks which are recorded to the USB device will be converted into MP3 format.
- You cannot start recording into a USB device while “READ USB” is shown on the display.
- Some USB devices have limit of recordable track number in the root group. Select another group or make a new group to record tracks when the number of target tracks to record is over the limit.
- Do not disconnect a USB device while playing/recording/editing. It may cause malfunction.
- Select the Stereo Mode (“STEREO”—see page 15) for multi-channel encoded software to downmix its multi-channel sound; otherwise, you can only record the front left/right sound onto a tape.

Recording from a CD onto a USB device

You can record tracks in digital recording from a Audio CD onto a USB device.

- Do not vibrate the System while recording/editing tracks. Take care especially while “WAIT” and “EDITING” are shown on the display. It may damage the recorded tracks on the System.
- See page 52 for more information about the warning messages shown on the display.

1 Connect a recordable USB device to the (REC/PLAY) terminal.

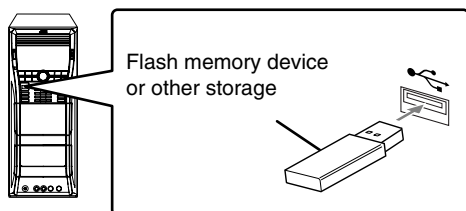

2 Select the disc number you want to record and stop playback.

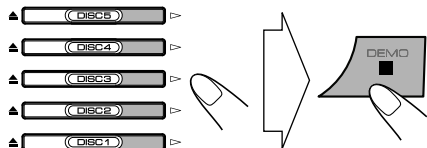

- You can use also the disc number buttons on the remote control.

3 Enter recording mode.



4 Select a group to record tracks into.



- You can also select a group from a list shown on the TV screen.

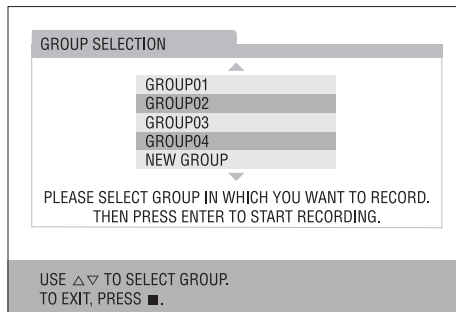

- If “NEW GROUP” is selected, the System will automatically create the new group as “001_group.” If “001_group” already exists, “002_group,” “003_group,” etc. will be created.

5 Start recording.

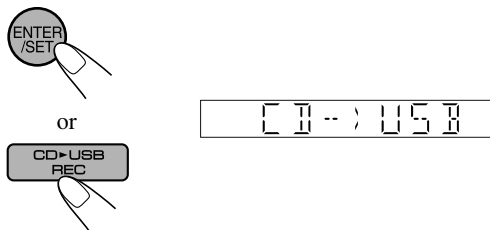

Both recording and playback start at the same time. The System records from the beginning of the disc selected in step 2.

When playback of the disc ends, recording also stops.

- You cannot change the source while recording.
- If Program Play is activated (see “Programming the Playing Order” on page 20), the tracks are recorded in the programmed order.

| To stop recording manually: | To record a playing track (1 track): |
|-----------------------------|--|
| | During play or pause... |
| | Then, follow steps 4 and 5 on this page. |

- When you want to start recording from another track than the first one, select the track by pressing <left><left>/>>>> after step 2.

Recording onto a Tape INFO

You can use type I tapes for recording.

- To play a tape, see page 12.

1 Insert a recordable cassette into deck B.

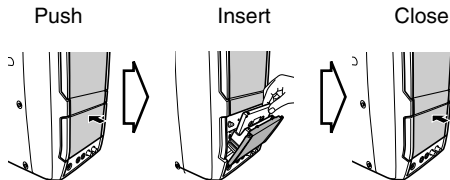

2 Check the tape running direction and Reverse Mode settings on the display.

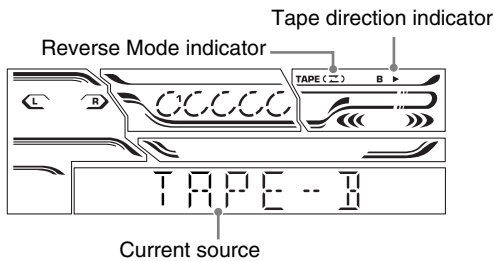

To change the direction

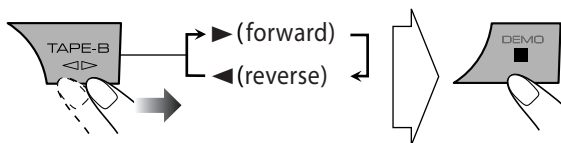

Change the Reverse Mode if necessary

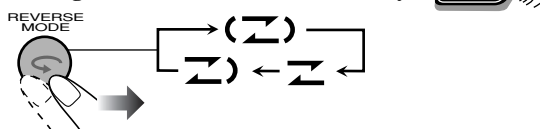

| | |
|--|--|
| | To record on both sides. • When using Reverse Mode, start recording in the forward (▶) direction. |
| | To record on only one side. |

3 Start playing the source—"TUNER FM," "TUNER AM," "DVD/CD," "USB," "TAPE-A" or "AUX."

- When recording from a disc/USB mass storage class device, you can also use "Synchronized Recording" (see page 32).
- When recording from deck A, you can also use "Dubbing" (see "Dubbing Tapes" on the right column).

4 Start recording.



To stop recording

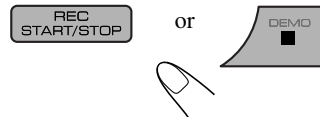

Dubbing Tapes Main Unit ONLY

You can record a tape from deck A to deck B.

1 Change the source to "TAPE".

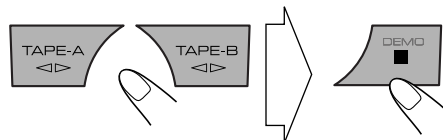

2 Insert the source cassette in deck A, and a recordable cassette in deck B.

3 Check the tape running direction and Reverse Mode settings on the display.

See step 2 of "Recording onto a Tape" on the left column.

4 Start dubbing.



- When either tape playback or recording ends, both cassette decks stop at the same time.

To stop dubbing

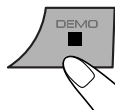

Synchronized Recording onto a Tape INFO

You can start and stop both playback and tape recording at the same time.

- This function is available only for CD/VCD/SVCD/DVD Video and Audio files.
- Not available with Random Play.

- 1 Load a disc or connect a USB mass storage class device and insert a recordable cassette.**
- 2 Check the tape running direction and Reverse Mode settings on the display.**
 - See step 2 of “Recording onto a Tape” on page 31.
- 3 Select the source you want to record.**

- When recording from the disc:
Select the disc number you want to start recording from.

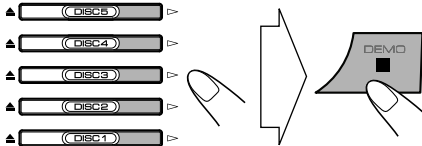

- When recording from the USB mass storage class device:

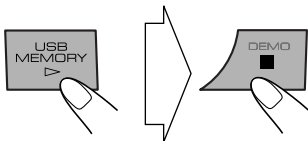

For recording desired tracks/files from discs:

You can program tracks/files to record in your preferred order.

Select Program Play (and make a program; see page 20) before starting playback.

4 Start recording.



Playback and recording start from the first track/file.

- The System automatically creates 4-second blank between the tunes recorded on the tapes.

When either playback or recording ends, both playback and recording stop at the same time.

To record only your favorite track/file—One Track Recording onto a Tape

You can specify track/file to be recorded on the tape while listening to a disc/USB mass storage class device.

- This function is available only for CD/VCD/SVCD and Audio files (without PBC for SVCD/VCD).
- Not available with Program Play and Random Play.

While the track/file you want to record is playing...



Playback returns to the beginning of that track/file and the track/file is recorded on the tape. After recording, both playback and recording stop.

To cancel while recording

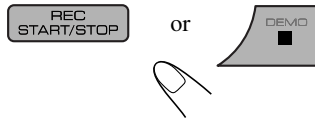

Editing Operations

Remote control

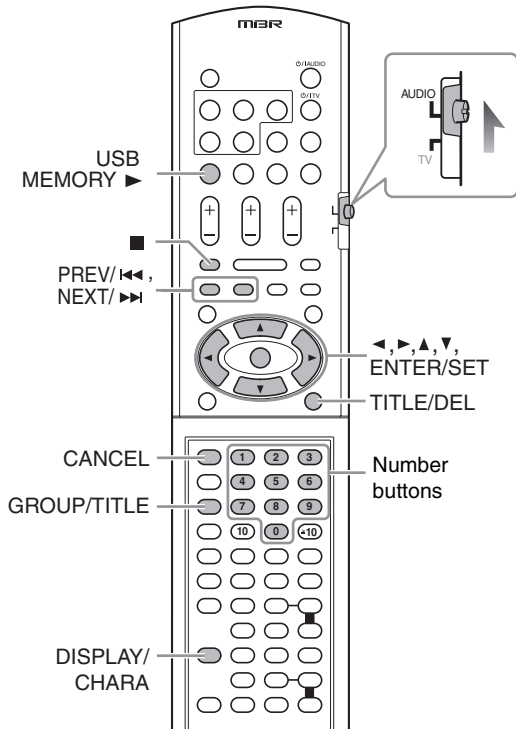

Giving (Editing) Titles to Tracks/Groups



You can give titles to the tracks (up to 24 characters) and groups (up to 28 characters) in the USB device.

- While playing, you cannot edit track/group titles.
- See page 52 for more information about the warning messages shown on the display.

1 Connect a USB device to the (REC/PLAY) terminal.

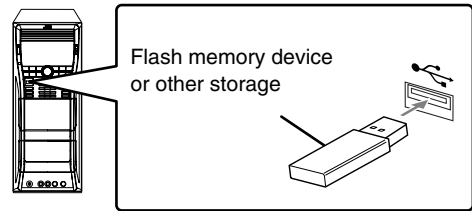

2 Select “USB” as the source and stop playback.

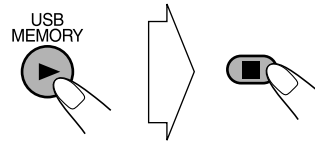

3 Select a track/group you want to edit.

To select a track:

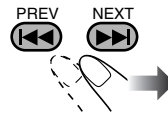

To select a group:

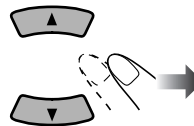

4 Select the track/group title editing mode.

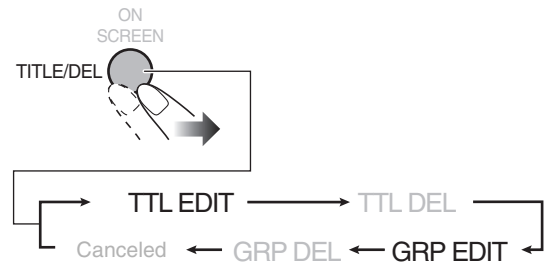

TTL EDIT For editing a track.

GRP EDIT For editing a group.

5 Confirm the selection.

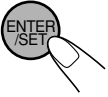

6 Enter a title.

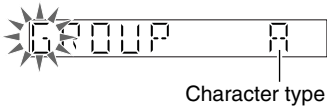

Ex.: When "GRP EDIT" is selected in step 4

- For entering a title, see "How to enter titles" on page 35.
- You can also enter a title using the TV on-screen.

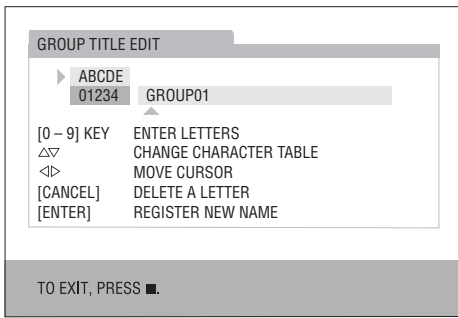

7 Finish the procedure.



"EDITING" and "FINISH" appear on the display.

- To give title to other groups/tracks, repeat steps 3 to 7.

To give a title to a new group before recording

- When you record tracks into "NEW GROUP" on a USB device (see step 4 of "Recording from a CD onto a USB device" on page 30), you can give a group title before starting to record.

- ① After selecting "NEW GROUP" in step 4...

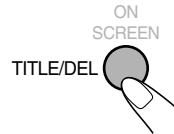

- ② Edit the group title.

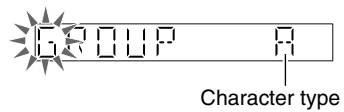

- For entering a title, see "How to enter titles" on page 35.

- ③ Finish the procedure.



Recording starts.

How to enter titles



1 Select the character type.

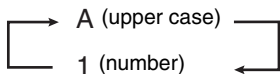
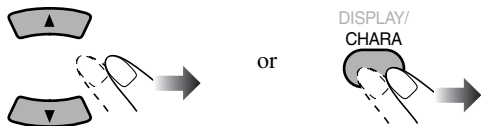

2 Enter a character.

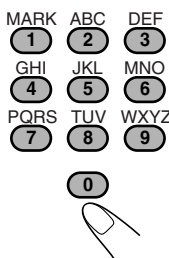

- Several characters are assigned to one button. Press the button repeatedly until the desired character is displayed.
- For available characters, refer to “Available Characters” on the right column.

3 Confirm the entry.



- “NO TITLE” appears on the display if no characters is entered in step 2. Enter a title.

To move the character entry position

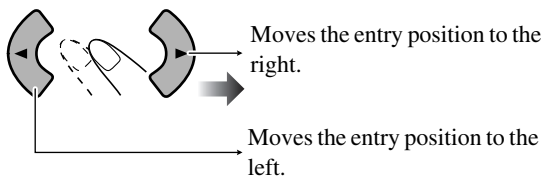

To erase a character

When the character entry position is on the character you want to erase...



To enter a space

Select the space from “Symbols.” (See “Available Characters” below.)

- You can also enter a space at the end of a title by pressing .

To quit title entry

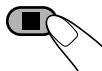

- The entered titles are not stored.

Available Characters

| Button | Uppercase character | Numerical character |
|-----------|--|---------------------|
| MARK ① | (Space), !, #, \$, %, &, ', (,), +, -, ., =, @, - | 1 |
| ABC ② | ABC | 2 |
| DEF ③ | DEF | 3 |
| GHI ④ | GHI | 4 |
| JKL ⑤ | JKL | 5 |
| MNO ⑥ | MNO | 6 |
| PQRS ⑦ | PQRS | 7 |
| TUV ⑧ | TUV | 8 |
| WXYZ ⑨ | WXYZ | 9 |
| ⑩ | — | 0 |

Erasing Tracks or Groups

You can erase tracks/groups on the USB device.

- Once the tracks are erased, you cannot resume them.

1 Connect a USB device to the (REC/PLAY) terminal.

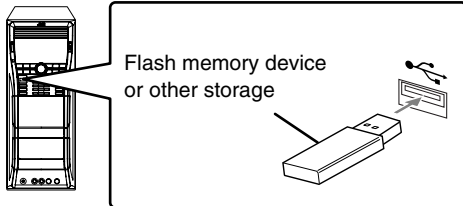

2 Select "USB" as the source and stop playback.

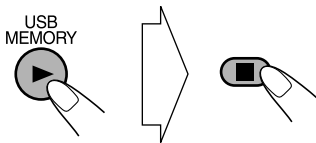

3 Select a track/group you want to erase.

To select a track:

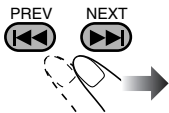

To select a group:

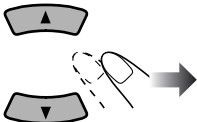

4 Select the track/group erase mode.

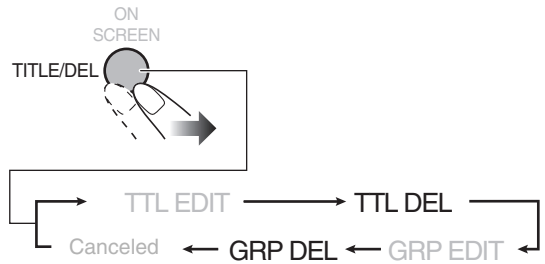

TTL DEL For deleting a track.

GRP DEL For deleting a group.

5 Confirm the selection.

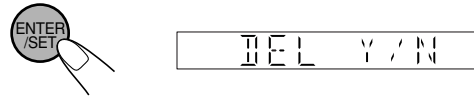

- To quit erasing, press CANCEL.

6 Erase your selection.

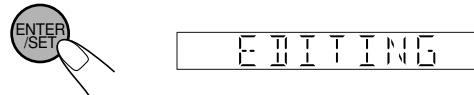

- When you delete the last track in a group, the group is also deleted.

Enjoying Karaoke

Remote control

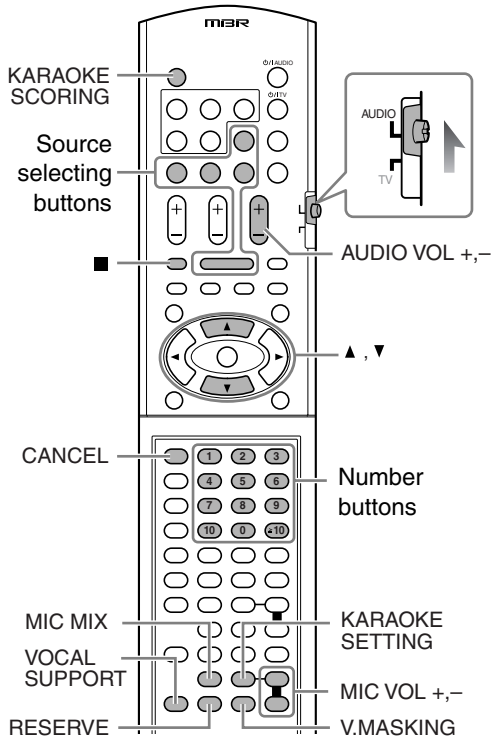

Main unit

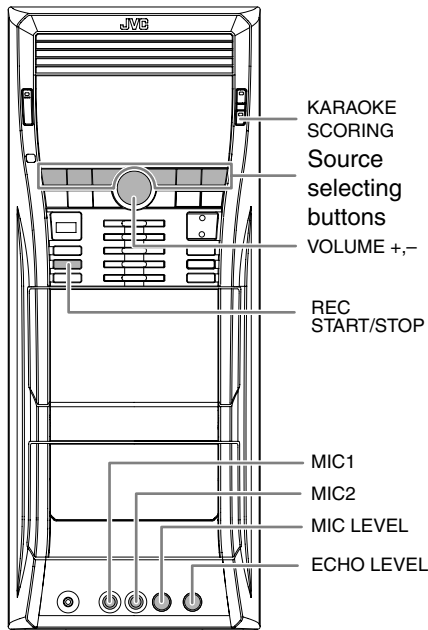

DO NOT keep the microphones connected while they are not in use.

- When you activate the Mic Mixing or Vocal Masking, the surround modes you selected will be changed to “ALL CH ST” temporarily (“AUTO” will be changed to “ALL CH ST” and “STEREO” will remain as “STEREO”).

IMPORTANT

- Always set MIC LEVEL to “0” when connecting or disconnecting the microphone.
- MIC LEVEL adjustment is valid for both microphones connected to the MIC1 and MIC2 jacks.
- MIC LEVEL and MIC VOL mentioned in this Instruction Book carry the same meaning.

Singing Along (Karaoke)

You can enjoy singing along (Karaoke) by using one or two microphones.

- By pressing REC START/STOP, you can record your singing-along.

1 Turn MIC LEVEL to “0”.



2 Connect the microphone(s) (not supplied) to the MIC1 and/or MIC2 jack.

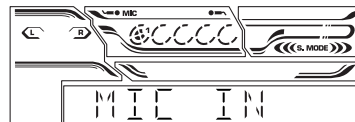

Mic Mixing will be automatically activated.

3 Start playing a source—“TUNER FM,” “TUNER AM,” “DVD/CD,” “USB,” “TAPE-A,” “TAPE-B” or “AUX.”

4 Sing into the microphone.

5 Adjust the MIC LEVEL and VOLUME.

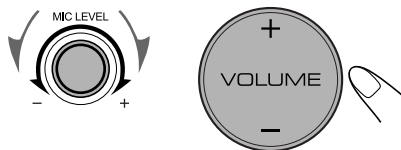

To use microphone only, select “DVD/CD” or “USB” in step 3, but do not start playback.

To cancel Mic Mixing

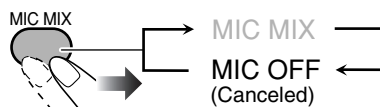

- To activate Mic Mixing, select MIC MIX.

Adjusting the Sound Track for Karaoke



You can adjust the sound track for Karaoke.

For stereo (2-channel) source: By selecting VOCAL MASK, you can reduce the lead vocal—Vocal Masking.

For karaoke disc: By selecting R CHANNEL or L CHANNEL, you can select the audio channel to play.

While Mic Mixing is activated...

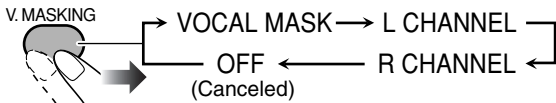

| | |
|-------------------|---|
| VOCAL MASK | Reduces the vocal from stereo (2-channel) source. |
| L CHANNEL | Reproduce only the left audio channel. |
| R CHANNEL | Reproduce only the right audio channel. |

To return to normal playback, select “OFF.”

To return to normal playback temporarily

This function allows you to recover the lead vocal temporarily for your reference.

While Vocal Masking, L CHANNEL or R CHANNEL is activated...

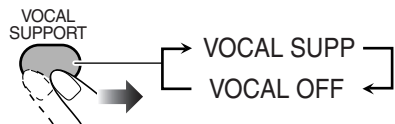

The vocal or stereo effect will be restored temporarily.

To return to Vocal Masking, L CHANNEL or R CHANNEL, press the same button again.

Scoring Your Karaoke Skill

INFO

This System can score your Karaoke skill by comparing your singing along with the vocal on the playback source.

- This function is available only for disc/USB mass storage class device playback.
- It is recommended to select the sound track as follows (see also page 17):

For Karaoke DVD Video: Select a sound track with vocal.

For Karaoke SVCD/VCD: Select “ST,” “ST1,” or “ST2.”

After selecting a sound track, select VOCAL MASK, L CHANNEL or R CHANNEL using the V.MASKING button (see the left column).

1 Select “DVD/CD” or “USB” as the source.

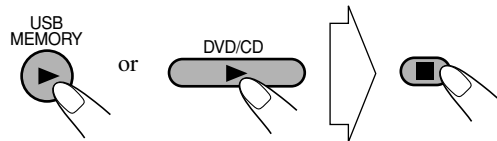

2 Connect the microphone(s) (not supplied) to the MIC1 and/or MIC2 jack.

Mic Mixing will be activated.

- If a microphone is already connected but Mic Mixing is not activated, use the MIC MIX button to activate Mic Mixing (see page 37).

3 Activate Karaoke Scoring.

KARAOKE SCORING



- “KSCORE ON” appears on the display.
- During Karaoke Scoring, scoring will start when playback is started.
- To cancel Karaoke Scoring before playback, press the same button again. “KSCORE OFF” appears on the display.

4 Start playback and sing into the microphone.

Karaoke Scoring starts.

- Adjust echo level and key if you want. (See “To apply an echo to your voice” and “To adjust the key” on page 39.)
- When you press ◀◀ or ▶▶, Karaoke Scoring is canceled and restarts from the selected track/file.

Continued on the next page...

After the song ends, playback stops and the score board appears on the TV screen with fanfare.

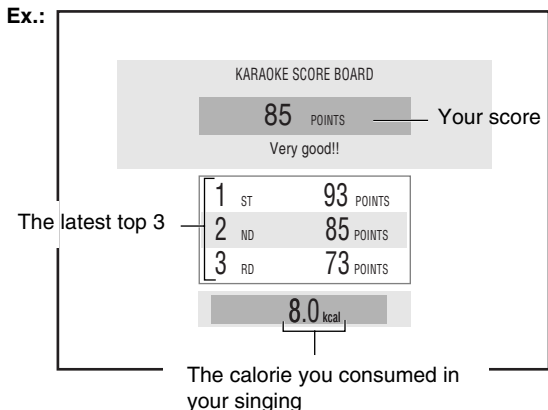

- When you press **II**, Karaoke Scoring is canceled. When playback starts again, Karaoke Scoring restarts.
- If you do not sing for about 2 minutes after Karaoke Scoring starts, Karaoke Scoring is canceled. If you sing a song too quietly for the System to detect your voice for about 2 minutes after Karaoke Scoring starts, Karaoke Scoring may be canceled.
- To obtain a correct scoring result, it is recommended to sing the song completely. If the singing time is less than 3 minutes, the scoring result may be "0" or incorrect.

To stop the playback in the middle of the song, press **■**. Karaoke Scoring is not canceled and your singing along is scored until that time.

To activate Karaoke Scoring in the middle of the song, press KARAOKE SCORING. "SCORING START" appears on the display, then scoring starts from that point.

To deactivate Karaoke Scoring in the middle of the song, press KARAOKE SCORING. "SCORING CANCEL" appears on the display.

- Once you deactivate Karaoke Scoring in the same song during playback, pressing KARAOKE SCORING switches "KSCORE ON" and "KSCORE OFF" alternately.
- When you reactivate Karaoke Scoring in the same song during playback and "KSCORE ON" is selected, scoring starts from the next track.

Changing the Karaoke Setting

You can change five settings for Karaoke.

- To exit from Karaoke setting, wait for several seconds after the setting is done.

To apply an echo to your voice

1



* Appears only when "DVD/CD" or "USB" is selected as the source with Mic Mixing activated.

2 Adjust the echo level.

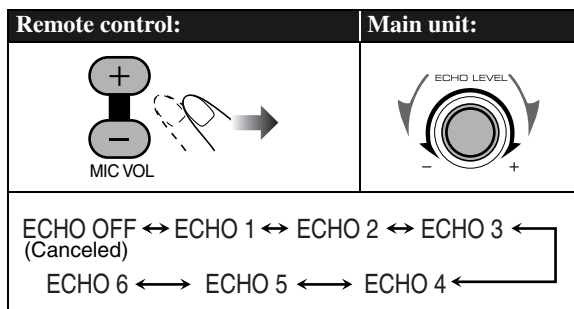

- As the number increases, echo level also increases.

To adjust the key

- This function is available for disc/USB mass storage class device playback.
- This function is available only for CD/VCD/SVCD/DVD Video and Audio files.
- The Key adjustment will be canceled when you deactivate Mic Mixing, or select another disc, track or file.

1 Select "DVD/CD" or "USB" as the source.

2 Connect the microphone(s) (not supplied) to the MIC1 and/or MIC2 jack.

Mic Mixing will be automatically activated.

- If a microphone is already connected but Mic Mixing is not activated, use the MIC MIX button to activate Mic Mixing (see page 37).

3 Start playback, then...



4 Adjust the key.

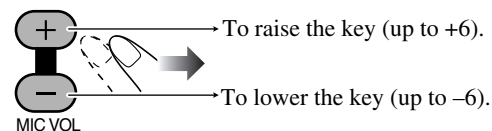

To return to normal key, select "0."

To change the scoring level

You can change the scoring level of Karaoke Scoring.

- This function is available only for disc/USB mass storage class device playback.

- 1 Select “DVD/CD” or “USB” as the source.
- 2 Connect the microphone(s) (not supplied) to the MIC1 and/or MIC2 jack.

Mic Mixing will be automatically activated.

- If a microphone is already connected but Mic Mixing is not activated, use the MIC MIX button to activate Mic Mixing (see page 37).

3



- 4 Select the scoring level setting.

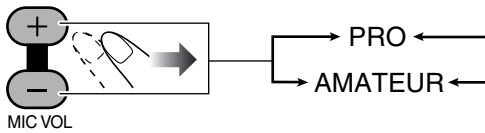

PRO The scoring level is strict.

AMATEUR The scoring level is lenient.

To turn on/off the fanfare

You can turn the fanfare on or off for Karaoke Scoring.

- This function is available only for disc/USB mass storage class device playback.

- 1 Select “DVD/CD” or “USB” as the source.

- 2 Connect the microphone(s) (not supplied) to the MIC1 and/or MIC2 jack.

Mic Mixing will be automatically activated.

- If a microphone is already connected but Mic Mixing is not activated, use the MIC MIX button to activate Mic Mixing (see page 37).

3

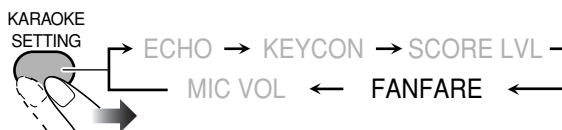

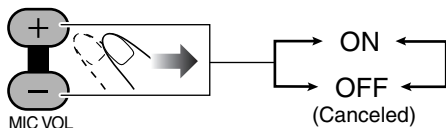

- 4 Select the fanfare setting.

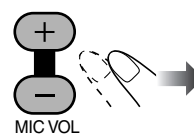

To change the mic volume

You can adjust the mic volume at any time.

| Remote control: | Main unit: |
|---|---|
|  |  |

MIC VOL 8

- The mic volume level can be adjusted in 16 steps (MIC VOL 0-MIC VOL 15).
- You can also call up the mic volume adjustment by pressing KARAOKE SETTING button and selecting “MIC VOL”.

Reserving Karaoke Songs

—Karaoke Program Play



You can determine the playback order of the titles, chapters, tracks or files on the disc player. You can program up to 12 steps.

- This function is not available for files in a USB mass storage class device.

- 1 Select “DVD/CD” as the source.
- 2 Turn the MIC LEVEL to “0”.



- 3 Connect the microphone(s) (not supplied) to the MIC1 or MIC2 jack.

Mic Mixing will be automatically activated.

- If a microphone is already connected but Mic Mixing is not activated, use the MIC MIX button to activate Mic Mixing (see page 37).

- 4 Activate Karaoke Program Play.

RESERVE



| No | Disc | Gr/Tt | Tr/Chap |
|----|------|-------|---------|
| 1 | ■ | | |
| 2 | | | |
| 3 | | | |
| 4 | | | |
| 5 | | | |

On the TV screen

- The PROGRAM indicator flashes during this mode.

- 5 Select songs you want for Karaoke Program Play.

Press the number buttons to select a song in the following order.

- ① Select a disc.
- ② Select a title/group.
- ③ Select a chapter/track/file.

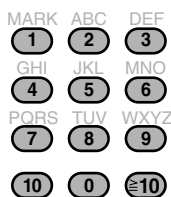

- To select a number, see “How to select a number” on page 8.
- To cancel the procedure, press RESERVE. The PROGRAM indicator disappears.

- 6 Start playback.

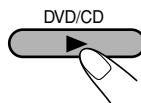

Karaoke Reserve screen disappears and playback starts in the order you have programmed.

- **For Karaoke Program Play with Karaoke Scoring:** Each time the song ends, playback stops and the score board appears. Press DVD/CD ► to start playback of the next track/file.

- 7 Sing into the microphone.

To check the programmed contents

RESERVE



Karaoke Reserve screen appears.

- You cannot display Karaoke Reserve screen while Karaoke Scoring is in use.

To modify the program

While Karaoke Reserve screen is shown on the TV...

To erase the unwanted step:

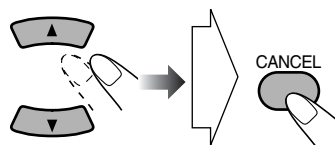

To erase the entire program, repeat the procedure.

To add steps in the program:

Repeat step 5.

Timer Operations

Remote control

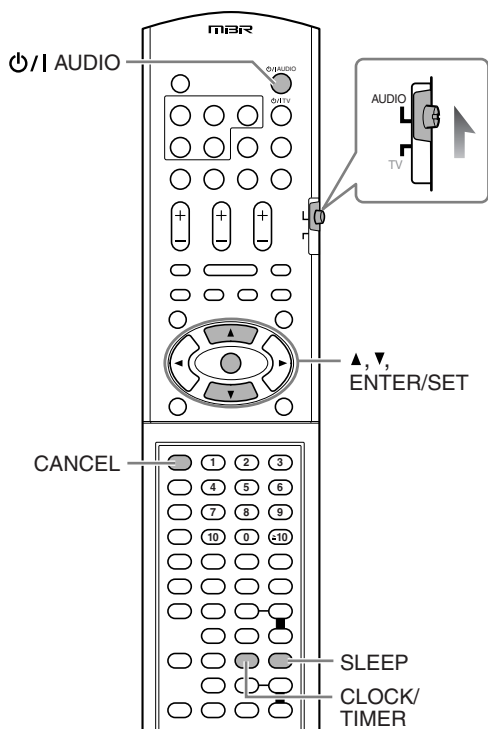

Setting the Timer



Using Daily Timer, you can wake up with your favorite song. On the other hand, with Recording Timer, you can make a tape of a radio broadcast automatically.

- You cannot activate Daily Timer and Recording Timer at the same time. (Activating one timer deactivates the other timer.)
- To correct a misentry during the process, press CANCEL. You can return to the previous step.

1 Select one of the timer setting modes—ON for Recording Timer or Daily Timer.

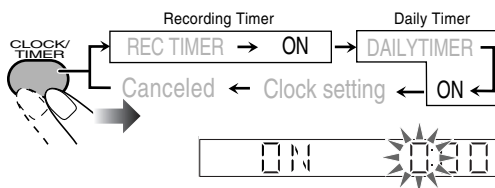

2 Make the timer setting as you want.

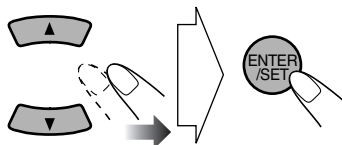

Repeat the procedure for the following settings until finished.

- ① Set the hour then minute for on-time.
- ② Set the hour then minute for off-time.
- ③ **For Recording Timer:** Select the playback source—“TUNER-FM,” “TUNER-AM” or “AUX.”
For Daily Timer: Select the playback source—“TUNER-FM,” “TUNER-AM,” “DISC,” “USB,” “TAPE-A,” “TAPE-B” or “AUX.”



EX.: When “TUNER-FM” is selected.

- When you select “AUX” as the source, you also need to set the timer of the external component.
- ④ **Select an item you want to play or record as follows.**
“TUNER-FM” and “TUNER-AM”: Preset station.
“DISC”: Disc, group/title and track/file/chapter.
“USB”: Group and file.
- ⑤ **Select the volume level.**
 - You can select the volume level (“VOLUME 0” – “VOLUME 30” and “VOLUME --”). If you select “VOLUME --,” the volume is set to the last level when the System has been turned off.

After making the timer setting, “SET OK” appears and your setting items appear on the display one after another.

3 Turn off the System (on standby) if you have set the timer with the System turned on.



How Recording Timer works

When Recording Timer has been set, the timer indicator (⏰) and the REC indicator are lit on the display.

Recording Timer works only once.

- Recording Timer starts working only when the System is turned off (on standby).

When the on-time comes

The System turns on, tunes in to the specified station, sets the volume level to the preset level, and starts recording.

When the off-time comes

The System stops recording, and turns off (on standby).

- The timer setting remains in memory until you change it.

How Daily Timer works

Once the Daily Timer has been set, the timer indicator (⏰) and DAILY indicator are lit on the display. Daily Timer is activated at the same time everyday until the timer is turned off manually (see below).

- Daily Timer starts working only when the System is turned off (on standby).

When the on-time comes

The System turns on, tunes in to the specified station or starts playing the specified source, and sets the volume level gradually to the preset level after about 30 seconds.

When the off-time comes

The System stops playback, and turns off (on standby).

- The timer setting remains in memory until you change it.

To turn off the Timer after the setting is done

You can turn off the timer after it has been set.

- Since Daily Timer works at the same time everyday, you may need to cancel it on some particular days.

1 Select the timer (REC TIMER or DAILYTIMER) you want to cancel.

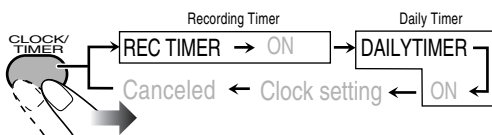

2 Turn off the selected timer.

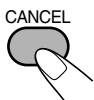

- The timer indicator (⏰) goes off.

To turn on the timer again, repeat step 1 and press ENTER/SET in step 2.

Turning Off the Power Automatically



With Sleep Timer, you can fall asleep while listening to music.

1 Specify the time (in minutes).

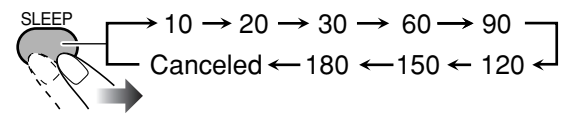

2 Wait until the set time disappears.

To check the time remaining until the shut-off time



- If you press the button repeatedly, you can change the shut-off time.

Timer Priority

If Timer settings overlap, the timers work as described below.

- Sleep Timer has priority over the Recording Timer and Daily Timer.

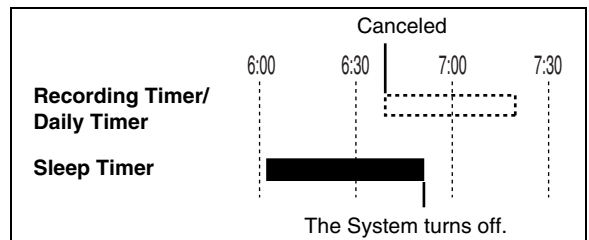

- In this case, Recording Timer/Daily Timer does not work.

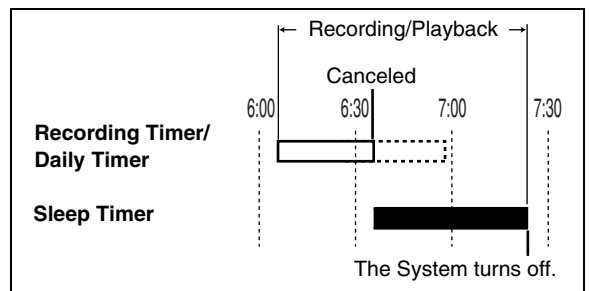

- In this case, Recording Timer/Daily Timer is canceled. (If Sleep Timer shuts off the System earlier than the off time you have set for Recording Timer, recording stops when Sleep Timer shuts off the System.)

Setup Menu Operations

Remote Control

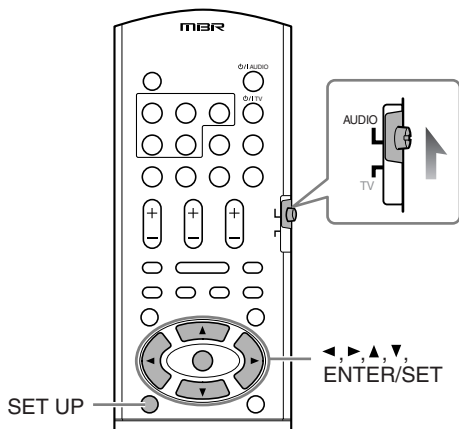

Basic Procedure

INFO

You can change the settings of the System.

- The Setup menu can be used only when “DVD/CD” or “USB” is selected as the source.

1 Press SET UP while playback is stopped.

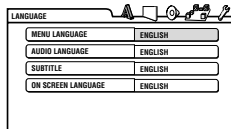

2 Press ► (or ◀) to select the menu.

3 Press ▼ (or ▲) to select the item.

4 Press ENTER/SET.

5 Press ▼ (or ▲) to select the options, then press ENTER/SET.

To erase a preference display, press SET UP.

A LANGUAGE menu

| Item | Contents |
|---------------------------|--|
| MENU LANGUAGE | You can select the initial menu language of DVD Video (see page 53). |
| AUDIO LANGUAGE | You can select the initial audio language of DVD Video (see page 53). |
| SUBTITLE | You can select the initial subtitle language of DVD Video (see page 53). |
| ON SCREEN LANGUAGE | You can select “ENGLISH,” “CHINESE,” or “SPANISH” as the on-screen language. |

PICTURE menu

| Item | Contents |
|-------------------------|---|
| MONITOR TYPE | You can select the monitor type to match your TV when you play back picture recorded for wide-screen televisions. 16:9 NORMAL/16:9 MULTI NORMAL (Wide television screen): Select this when the aspect ratio of your TV is fixed to 16:9. 16:9 AUTO/16:9 MULTI AUTO (Wide television screen): Select this when your TV is an ordinary wide TV. 4:3 LB/4:3 MULTI LB (Letter Box conversion): For a conventional (4:3) TV. Displays a wide-screen picture to fit the width of the TV screen keeping the aspect ratio. 4:3 PS/4:3 MULTI PS (Pan Scan conversion): For a conventional (4:3) TV. The picture is zoomed in to fill the screen vertically and the left and right sides of the picture are cut off. • By selecting “MULTI” mode, the color system of the System changes automatically to match the color system of the picture. For the color system setting, see page 6. |
| PICTURE SOURCE | You can obtain optimal picture quality by selecting the type of the video source. AUTO: Normally, select this option. The System recognizes the picture type (film or video source) of the current picture according to its information. FILM: For a film source picture. VIDEO: For a video source picture. |
| SCREEN SAVER | You can set the screen saver function to ON or OFF . ON: The on-screen display becomes dark when no operation is done for about 5 minutes. OFF: To cancel the screen saver. |
| FILE TYPE | You can select a file type to play. AUDIO: To play Audio files. (MP3/WMA/WAV files.) STILL PICTURE: To play Still Picture files. (JPEG file.) VIDEO: To play Video files. (MPEG-1/MPEG-2/ASF/DivX files.) |



AUDIO menu

| Item | Contents |
|-----------------------------|---|
| DIGITAL AUDIO OUTPUT | Set this item correctly when using the OPTICAL DIGITAL OUTPUT terminal on the rear. PCM ONLY: When connecting to audio equipment which is compatible with only linear PCM signals. DOLBY DIGITAL/PCM: When connecting to a Dolby Digital decoder or an amplifier with built-in Dolby Digital decoder. STREAM/PCM: When connecting to a DTS/MPEG Audio decoder or an amplifier with built-in DTS/MPEG Audio decoder. |
| D. RANGE COMPRESSION | You can enjoy a powerful sound at a low volume level while playing Dolby Digital software. AUTO: Select to apply the compression only to multi-channel encoded audio (except for 1-channel and 2-channel sources). ON: Select this to always apply the compression. |

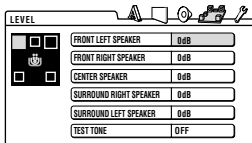
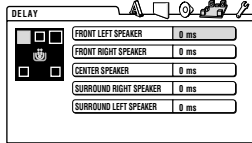

SPK. SETTING menu

| Item | Contents |
|---|--|
| LEVEL  | Select this item, then press ENTER/SET to show the LEVEL submenu for adjusting the speaker output level. FRONT LEFT/RIGHT SPEAKER, CENTER SPEAKER, SURROUND RIGHT/LEFT SPEAKER: Select the speaker, then adjust the output level (-6 dB to +6 dB in 1 dB steps). TEST TONE: Turns on/off the test tone. • Select "ALL CH ST," "MUSIC," or "MOVIE" (see page 15) to adjust the output level for all speakers with the test tone. |
| DELAY  | Select this item, then press ENTER/SET to show the DELAY submenu for adjusting the speaker delay time. FRONT LEFT/RIGHT SPEAKER, CENTER SPEAKER, SURROUND RIGHT/LEFT SPEAKER: Select the speaker, then adjust the delay time (0 ms to 15 ms in 1 ms steps). • Set one speaker to "0 ms," then set other speakers so that the sound from all speakers can reach you at the same time. |



OTHERS menu

| Item | Contents |
|--------------------------|---|
| RESUME | You can select Resume. ON: The System resumes playback from the position where playback has been stopped (not applicable for CD). OFF: Resume is deactivated. |
| ON SCREEN GUIDE | Activate or deactivate the on-screen guide. ON: Activate the on-screen guide. OFF: Deactivate the on-screen guide. |
| DivX REGISTRATION | The System has its own Registration Code. If necessary, you can confirm it. Once you have played back a DivX file in which the Registration Code is recorded, the System's Registration Code is overwritten for copyright protection. |

Operating the TV



Remote control

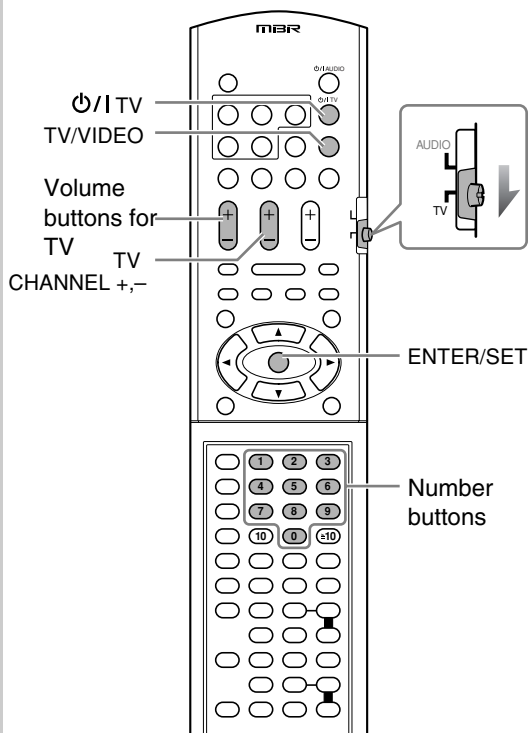

| Manufacturer's code | |
|---------------------|-------------|
| Manufacturer | Code number |
| JVC | 01 |
| Hitachi | 10 |
| Magnavox | 02 |
| Mitsubishi | 03 |
| Panasonic | 04, 11 |
| Philips | 15 |
| RCA | 05 |
| Samsung | 12 |
| Sanyo | 13, 14 |
| Sharp | 06 |
| Sony | 07 |
| Toshiba | 08 |
| Zenith | 09 |

Operating the TV

You can operate JVC's or other manufacturers' TV using the remote control supplied for this System.

1 Slide the AUDIO/TV selector to "TV."

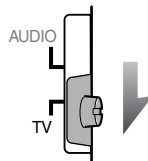

2 Press and hold until the following steps are completed.



3



4 Enter the 2-digit manufacturer's code number.



5 Release Power/I TV.

To operate the TV

| To turn on or off the TV: | To select the input mode (either TV or VIDEO): | To adjust TV volume: |
|---------------------------|--|----------------------|
| | | |
| To select the TV channel: | | |
| | or | |

Additional Information

Learning More about This System ● ● ●

Connections (see pages 3 to 6)

Changing the Color System and Scanning Mode:

- If you play back an NTSC disc/file with the color system set to “PAL (PROG),” the disc/file will be reproduced using “PAL 60” format; however, if the TV does not support this format, the screen may not display properly.
- If you play back a PAL disc/file with the color system set to “NTSC (PROG),” you can watch the playback pictures, but the following symptoms may occur:
 - The items on the menu will be blurred, and be shown slightly shifted when highlighted.
 - The aspect ratio of the picture may differ from the original aspect ratio.
 - The picture movement is not smooth.
- You cannot change the scanning mode to progressive in the following cases:
 - When your TV does not support the progressive video input.
 - When you have not connected your TV to the unit using a component video cord.
- When you play back an NTSC disc/file in progressive scanning mode either NTSC PROG or PAL PROG, the System outputs the NTSC signal regardless of the color system settings.

Daily Operations—Playback (see pages 8 to 12)

Listening to the Radio:

- If you store a new station into an occupied preset number, the previously stored station in that number will be erased.

Playing Back a Disc/USB Mass Storage Class Device:

- When you change the source to “DVD/CD” or “USB,” it may take a while to activate the source.
- While the System is reading a disc, the source may not change to “USB MEMORY” correctly. In this case, press ■, then reactivate “USB MEMORY” as the source.
- On some discs/files, the actual operations may be different from what is explained in this manual, due to the programming and disc structure; such differences are not a malfunction of this System.
- For playback of files in the USB mass storage class device...
 - When connecting a USB mass storage class device, refer also to its manual.
 - Connect one USB mass storage class device to the System at a time. Do not use a USB hub.
 - You cannot charge any USB mass storage class device through the ⏪ (REC/PLAY) terminal of this System.
 - While playing back a file in a USB mass storage class device, do not disconnect the device. It may cause a malfunction of both the System and the device.
 - JVC bears no responsibility for any loss of data in the USB mass storage class device while using this System.
 - When connecting with a USB cable, use the cable whose length is less than 1 m.
 - This System is compatible with USB 2.0 Full Speed.
- You can play back the following types of files in a USB mass storage class device (maximum data transfer rate: 2 Mbps):
 - Audio: MP3, WMA, WAV
 - Still picture: JPEG
 - Video: MPEG-1, MPEG-2, ASF, DivX (maximum frame rate of 30 fps for progressive)
- This System may not play back some files even though their formats are listed above.
- You cannot play back a file larger than 2 Gigabyte.
- When playing a file which has a high transfer rate, frames or sounds may be dropped during playback.
- This System cannot recognize a USB mass storage class device whose rating is other than 5 V and does not exceed 500 mA.
- This System may not play back some USB mass storage class device and does not support DRM (Digital Rights Management).
 - It will take some time to start up a Digital Audio Player (DAP) larger than 1 Gigabyte.
 - You cannot send any data to your USB mass storage class device from this System.
- For MP3/WMA/WAV playback...
 - MP3/WMA/WAV discs require a longer readout time than regular CDs. (It depends on the complexity of the group/file configuration.)
 - Some MP3/WMA/WAV files cannot be played back and will be skipped. This results from their recording processes and conditions.
 - When making MP3/WMA/WAV discs, use ISO 9660 Level 1 or Level 2 for the disc format.
 - This System can play back MP3/WMA/WAV files with the extension code <.mp3>, <.wma> or <.wav> (regardless of the letter case—upper/lower).
 - It is recommended that you make each MP3/WMA/WAV files at the following conditions:
 - MP3/WMA: At a sampling rate of 44.1 kHz and bit rate of 128 kbps.
 - WAV: 44.1 kHz/16 bit Linear PCM.
 - This System cannot play back files made at bit rate of less than 64 kbps.
- For DVD-VR playback...
 - **Original Program:** The System can play back the original picture in the recorded order.
 - **Play List:** The System can play back the play list edited by the recording equipment.
 - For details about DVD-VR format and play list, refer to the manual of the recording equipment.
- For JPEG playback...
 - This System can play back JPEG files with the extension code <.jpg> or <.jpeg> (regardless of the letter case—upper/lower).
 - It is recommended that you record a file at 640 x 480 resolution. (If a file has been recorded at a resolution of more than 640 x 480, it will take a long time to be shown.)

- This System can play only baseline JPEG files*. Progressive JPEG files* or lossless JPEG files* cannot be played.
 - * Baseline JPEG format: Used for digital cameras, web, etc.
 - Progressive JPEG format: Used for web.
 - Lossless JPEG format: An old type and rarely used now.
- For MPEG-1/MPEG-2 playback...
 - This System can play back MPEG-1/MPEG-2 files with the extension code <.mpg> or <.mpeg> (regardless of the letter case—upper/lower).
 - The stream format should conform to MPEG system/program stream.
 - 720 x 576 pixels (25 fps)/720 x 480 pixels (30 fps) is recommended for the highest resolution.
 - This System also supports the resolutions of 352 x 576/480 x 576/352 x 288 pixels (25 fps) and 352 x 480/480 x 480/352 x 240 pixels (30 fps).
 - The file format should be MP@ML (Main Profile at Main Level)/SP@ML (Simple profile at Main Level)/MP@LL (Main Profile at Low Level).
 - Audio streams should conform to MPEG1 Audio Layer-2 or MPEG2 Audio Layer-2.
- For ASF playback...
 - This System can play back ASF files with the extension code <.asf> (regardless of the letter case—upper/lower).
 - This System supports ASF files whose resolution is 352 x 288 pixels or less.
 - Some recorded files may not be able to played back depending on file characteristics, kind of digital still/video cameras, or recording conditions.
- For DivX playback...
 - The System supports DivX 6.x, 5.x, 4.x and 3.11.
 - When making a disc, use the UDF-Bridge format. “Multi-border” is not supported.
 - The System supports DivX files whose resolution is 720 x 480 pixels or less (30 fps), and 720 x 576 pixels or less (25 fps).
 - Audio stream should conform to Dolby Digital, MPEG1 Audio Layer-2 or MPEG Audio Layer-3 (MP3).
 - This System can play back DivX files with the extension code <.divx> <.div> <.avi> (regardless of the letter case—upper/lower).
 - The System does not support GMC (Global Motion Compression).
 - The file encoded in the interlaced scanning mode may not be played back correctly.

Daily Operations—Sound & Other Adjustments (see pages 13 to 16)

Adjusting the Speaker Output Level :

- The channel level cannot change during Mic Mixing, Vocal Masking or Karaoke Scoring.

Reinforcing the Bass Sound:

- The adjustment for the subwoofer level does not affect the sound through the headphones.

Applying an Optimal Bass Sound Effect—VARIO BASS

- If you plug in a microphone and Mic Mixing is activated, the System will automatically switches the mode to LITE.n.EASY even if the mode is set to OFF.

Selecting the Surround Modes:

- Dolby Pro Logic II Modes: Dolby Pro Logic II Mode is a multi-channel playback format to convert 2-channel sources into 5.1-channels. Dolby Pro Logic II reproduces spacious sound from original sound without adding any new sounds or tonal colorations.
- While you use the headphones, the Surround Mode is canceled temporarily.
- Dolby PL II MUSIC/MOVIE take no effect to MPEG-1/MPEG-2/ASF/DivX files.

Setting the Clock:

- “0:00” will flash on the display until you set the clock.
- The clock may gain or lose 1 to 2 minutes per month. If this happens, reset the clock.

Unique Video Disc/File Operations (see pages 17 to 19)

Selecting the Audio Track:

- On some disc/file, you cannot change audio languages while playing back.

Special Picture Playback:

- During slow-motion playback, no sound will be reproduced.
- While zoomed in, the picture may look coarse.

Advanced Playback Operations (see pages 20 to 22)

Programming the Playing Order—Program Play:

- While programming steps...
 - Your entry will be ignored if you have tried to program an item number that does not exist on the disc (for example, selecting track 14 on a disc that only has 12 tracks).
- For SVCD/VCD/CD loaded on the other tray than the current one, the System may prompt for the group number entry as well; however, these entries will be ignored during playback.
- The programmed contents will remain until you erase it.
- While the PROGRAM indicator is on, you cannot change the disc to play. (DISC 1 – DISC 5 on the remote control and ► on the main unit do not work.)

On-Screen Operations (see pages 23 to 28)

Operations Using the On-screen Bar:

- A-B Repeat is possible only within the same title or within the same track.

Recording Operations (see pages 29 to 32)

General:

- You cannot change the source during recording.

Recording onto a Tape:

- There is leader tape which cannot be recorded onto at the start and the end of cassette tapes. Thus, before recording, wind the leader tape first to ensure that the recording will be made without any music part lost.
- If no cassette is inserted or a protected tape has been inserted, “NO REC” appears on the display.
- The recording level is automatically set correctly. Thus, you can make sound adjustments other than Surround Mode, without affecting the recording level.
- While recording from disc/USB mass storage class device, plugging in and out headphones may cause sound distortion and affect the recording.
- When using Reverse Mode for recording, start recording in the forward (▶) direction first; otherwise, recording will stop when only one side (reverse) of the tape is recorded.

Synchronized Recording onto a Tape:

- You cannot open the disc tray while recording onto a tape using USB/DISC REC START button.
- Recording starts from the first track even if you have selected a track by using ◀◀/▶▶. To specify track(s) to record, program them (not applicable for USB mass storage class device) or use One Track Recording.
- While recording, you cannot use disc/USB mass storage class device operation buttons (except for ■).
- You cannot use Repeat Play during synchronized recording (Repeat Play will be canceled).
- USB/DISC REC START button does not work:
 - While playback is paused.
 - When Random Play mode is selected.
 - When playing back in Program Play mode.
- When using the Reverse Mode and the tape reaches its end in the forward direction (▶) during recording, the last song will be re-recorded at the beginning of the reverse side (◀).
- When using the Reverse Mode and the tape reaches its end in the reverse side (◀) during recording, recording stops even though the disc/USB mass storage class device is not entirely recorded.

About SCMS (Serial Copy Management System)

The System uses the Serial Copy Management System which allows only first-generation digital copies to be made of premastered software such as regular CDs. If you try to record from a duplicated CD-R or CD-RW into the USB device, “SCMS ERROR” appears on the display.

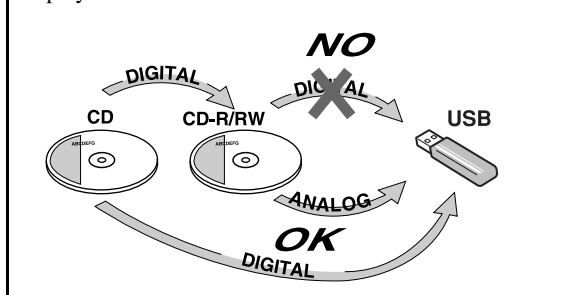

Editing Operations (see pages 33 to 36)

Giving (Editing) Titles to Tracks/Groups:

- When a track is recorded, the track title is given to the track automatically. When you give a title to the track, delete that title first, then enter your desired title.

Enjoying Karaoke (see pages 37 to 41)

General:

- When Mic Mixing or Vocal Masking is activated:
 - Multi-channel source will be down-mixed.
 - Dolby Pro Logic II will be canceled temporarily.
- When Mic Mixing is activated and ALL CH ST is selected as the Surround mode, the output level of surround speaker decreases.
- While recording onto a tape, Key adjustment, Echo and Vocal Masking will be recorded. However, while recording onto a tape using USB/DISC REC START, Key adjustment will not be recorded.
- While the System is turned on, connecting a microphone automatically activates Mic Mixing and all the Karaoke related functions.
- If you connect a microphone during the System turned off, press MIC MIX to activate Mic Mixing after turning the System on.

Adjusting the Sound Track for Karaoke:

- The Vocal Masking setting is not applied to the optical digital output signals through the OPTICAL DIGITAL OUTPUT terminal.
- On some music, Vocal Masking does not provide the correct effect.

Scoring Your Karaoke Skill:

- While Karaoke Scoring is in use, you cannot deactivate Mic Mixing or use MIC MIX, RESERVE and number buttons.
- Activating Karaoke Scoring cancels Repeat Play.

- You cannot use Karaoke Scoring during Program Play, Random Play, or recording. However, you can turn Karaoke Scoring on and off by using KARAOKE SCORING button during these play modes.
- The ranking (top 3) is cleared when you turn off the System.
- For some VCD, the Karaoke Scoring result may not appear at the end of the track if PBC is activated. In this case, press ■ to view your scoring result.

Reserving Karaoke Songs—Karaoke Program Play:

- You can use RESERVE button when a microphone is plugged in. However, you can cancel Karaoke Program Play using the button even if a microphone is not plugged in. In case you reactivate Karaoke Program Play, plug in a microphone.
- If you have selected a disc tray on which a disc containing Video files or JPEG file or DVD-VR is loaded, that disc number is skipped.
- If DVD-VR or a disc containing Video files and JPEG file is loaded on the current tray, you cannot activate Karaoke Program Play.
- When the track starts playback, that track number will be erased from the Karaoke Reserve screen (the programmed contents will remain until you erase it).
- While the PROGRAM indicator is flashing, you cannot change the disc to play. (DISC 1 – 5 on the remote control and ► on the main unit do not work.)

Timer Operations (see pages 42 to 43)

Setting the Timer:

- If you do not specify the preset station or track number correctly while setting a timer, the currently selected station or the first track will be played when timer is activated.
- When you unplug the AC power cord or if a power failure occurs, the timer will be canceled. You need to set the clock first, then the timer again.
- Without stopping the recording, you cannot change the source while Recording Timer is recording.
- Daily Timer will not work correctly for some DVDs.

Setup Menu Operations (see pages 44 to 45)

General:

- If the upper and lower parts of the menu are cut off, adjust the picture size control of the TV.

LANGUAGE menu:

- When the language you have selected for MENU LANGUAGE, AUDIO LANGUAGE, or SUBTITLE is not recorded on a disc, the original language is used as the initial language.

PICTURE menu—MONITOR TYPE:

- Even if “4:3 PS/4:3 MULTI PS” is selected, the screen size may become 4:3 letter box with some disc. This depends on how they are recorded.
- When you select “16:9 NORMAL/16:9 MULTI NORMAL” or “16:9 AUTO/16:9 MULTI AUTO” for a

picture whose aspect ratio is 4:3, the picture slightly changes due to the process for converting the picture width.

SPK. SETTING menu—DELAY:

- See the following diagram as an example for setting the delay time:

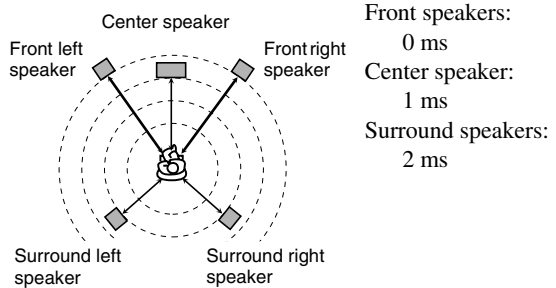

OTHERS menu—ON SCREEN GUIDE:

- The setup menu and on-screen bar will be displayed (and recorded) even though this function is set to “OFF.” Subtitles and the information for zoom-in always appear on the display regardless of this setting.

Maintenance ●●●●●●●●●●

To get the best performance of the System, keep your discs, tapes and mechanism clean.

Handling discs

- Remove the disc from its case by holding it at the edge while pressing the center hole lightly.
- Do not touch the shiny surface of the disc, or bend the disc.
- Put the disc back in its case after use to prevent warping.
- Be careful not to scratch the surface of the disc when placing it back in its case.
- Avoid exposure to direct sunlight, extreme temperatures, and moisture.

To clean the disc:

Wipe the disc with a soft cloth in a straight line from center to edge.

Handling cassette tapes

- If the tape is loose in its cassette, take up the slack by inserting a pencil in one of the reels and rotate it.
 - If the tape is loose, it may get stretched, cut, or caught in the cassette.
- Be careful not to touch the tape surface.
- Avoid the following places to store the tape—in dusty places, in direct sunlight or heat, in moist areas, on a TV or speaker, or near a magnet.

To keep the best recording and playback sound quality:

- Use a cotton swab moistened with alcohol to clean the heads, capstans and pinch rollers.

- Use a head demagnetizer (available at electronics and audio shops) to demagnetize the heads (when the System is turned off).

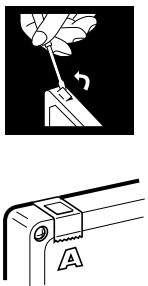

To protect your recording
Cassettes have two small tabs on the back to protect from unexpected erasure or re-recording.

To protect your recording, remove these tabs.

To re-record on a protected tape, cover the holes with adhesive tape.

Cleaning the System

- Stains should be wiped off with a soft cloth. If the System is heavily stained, wipe it with a cloth soaked in water-diluted neutral detergent and wrung well, then wipe clean with a dry cloth.
- Since the System may deteriorate in quality, become damaged or get its paint peeled off, be careful about the following:
 - DO NOT wipe it with a hard cloth.
 - DO NOT wipe it forcefully.
 - DO NOT wipe it with thinner or benzine.
 - DO NOT apply any volatile substance such as insecticides to it.
 - DO NOT allow any rubber or plastic to remain in contact for a long time.

Troubleshooting

If you are having a problem with your System, check this list for a possible solution before calling for service.

General:

Adjustments or settings are suddenly canceled before you finish.

⇒ There is a time limit. Repeat procedure again.

Operations are disabled.

⇒ The built-in microprocessor may malfunction due to external electrical interference. Unplug the AC power cord and then plug it back in.

Unable to operate the System from the remote control.

⇒ The path between the remote control and the remote sensor on the System is blocked.

⇒ The batteries are exhausted.

No sound is heard.

⇒ Speaker connections are incorrect or loose.

⇒ Headphones are connected.

No picture appears on the screen.

⇒ The video cord connections are incorrect or loose.

No picture is displayed on the TV screen, the picture is blurred, or the picture is divided into two parts.

⇒ The System is connected to a TV which does not support progressive video input.

⇒ Incorrect color system is selected (see page 6).

The left and right edges of the picture are missing on the screen.

⇒ Select “4:3 LB /4:3 MULTI LB” for “MONITOR TYPE” (see page 44).

Radio Operations:

Hard to hear broadcasts because of noise.

⇒ Antennas connections are incorrect or loose.

⇒ The AM loop antenna is too close to the System.

⇒ The FM antenna is not properly extended and positioned.

Disc/file Operations:

The disc does not play.

⇒ You have inserted a DVD Video whose Region Code is not correct. (“REGION ERR” appears on the display.)

⇒ The disc is placed upside down. Place the disc with the label side up.

ID3 Tag on an MP3 disc cannot be shown.

⇒ There are two types of ID3 Tag—Version 1 and Version 2. This System can only show ID3 Tag Version 1.

Groups and files are not played back as you expect.

⇒ The playing order is determined when the files were recorded. It depends on the application.

AV files are not played back.

⇒ The disc or USB mass storage class device includes different types of files (Audio file, Video file and Still picture file.). In this case, you can play back the files selected only by the “FILE TYPE” setting (see page 44).

⇒ You have changed the “FILE TYPE” setting after the System read the disc or the USB mass storage class device. In this case, reload the disc or disconnect the USB mass storage class device and connect it again.

The disc sound is discontinuous.

⇒ The disc is scratched or dirty.

The playback sounds strange.

⇒ Cancel Vocal Masking (see page 38).

⇒ Cancel Key adjustment (see page 39).

No subtitle appears on the TV screen though you have selected the initial subtitle language.

⇒ Some discs are programmed to always display no subtitle initially. If this happens, press SUB TITLE after starting play (see page 18).

Audio language is different from the one you have selected as the initial audio language.

⇒ Some discs are programmed to always use the original language initially. If this happens, press AUDIO/MPX after starting play (see page 17).

The disc tray does not open or close.

⇒ The AC power cord is not plugged in.

⇒ Child Lock is in use. “LOCKED” appears on the display window (see page 22).

⇒ Program Play is in use. Cancel Program Play (see page 21).

Tape Operations:

The cassette holder cannot be opened.

⇒ Power supply from the AC power cord has been cut off while the tape was running. Turn on the System.

Recording Operations:

“CANNOT REC” appears on the display.

⇒ The System cannot perform recording.

Unable to record into the USB device.

⇒ The capacity of the USB device is full. Erase some tracks.

⇒ There have been 999 tracks or group on the USB device you want to record into. Erase unwanted tracks.

⇒ The USB device is write-protected.

⇒ The connected USB device is incompatible to this System.

Unable to record onto the tape.

⇒ Small tabs on the back of the cassette are removed. Cover the holes with adhesive tape.

⇒ Karaoke Scoring is in use. Cancel Karaoke Scoring (see page 38).

Editing Operations:

Unable to assign title to tracks on the USB device.

⇒ When a track is damaged, you cannot edit that track. In this case, turn off the System and turn on again.

⇒ The USB device is write-protected.

Karaoke Operations:

Karaoke function cannot be activated.

⇒ Ensure at least one microphone is connected and Mic Mixing is activated. If a microphone is not connected, you cannot activate Mic Mixing and any other Karaoke related function.

Karaoke Scoring cannot be activated.

⇒ You cannot use Karaoke Scoring while recording, or while the disc menu for DVD Video/SVCD/VCD is shown on the TV screen.

Scoring result seems wrong (or “- -” appears).

⇒ The time of playback and singing along are too short for Karaoke Scoring. It is recommended to sing more than 3 minutes to obtain a correct scoring result.

⇒ No sound from the microphone or the input level (MIC LEVEL) is too low.

⇒ You have sung too quietly.

Timer Operations:

Daily Timer or Recording Timer does not work.

⇒ The System has been turned on when the on-time comes. Timer starts working only when the System is turned off.

Display Messages for Recording or Editing

Operations

NO DEVICE

- No USB device is connected or the connected USB device is not compatible with this System.

PROHIBIT

- The USB device is prohibited from editing file/group.

DATA FULL

- The capacity of memory for USB device is full.

TRACK FULL

- More than 999 tracks are included in one group in the USB device.

PROTECTED

- The track is write-protected by other components.

SCMS ERROR

- You cannot record from a duplicated CD-R or CD-RW into the USB device.

SAME TITLE

- Same title is already entered (blank) when entering the new file/group title.

NO TITLE

- No title is entered (blank) when editing the file/group title.

DEVICE ERR

- The unit has failed to read the USB device.

NO REC

- The tracks cannot be recorded onto the tape and USB device.

OPTICAL DIGITAL OUTPUT Signals

| DIGITAL AUDIO OUTPUT Playback disc/file | Output Signals | | |
|--|---|-----------------------------|---|
| | STREAM/PCM | DOLBY DIGITAL/PCM | PCM ONLY |
| DVD Video | | | |
| with 48 kHz, 16/20/24 bit Linear PCM | 48 kHz, 16 bit Linear PCM* | | |
| with 96 kHz, Linear PCM | 48 kHz, 16 bit Linear PCM | | |
| with Dolby Digital | Dolby Digital bitstream | | 48 kHz, 16 bit Linear PCM |
| with DTS | DTS bitstream | 48 kHz, 16 bit Linear PCM | |
| DVD-R/-RW in DVD-VR format | | | |
| with 48 kHz, 16/20/24 bit Linear PCM | 48 kHz, 16 bit Linear PCM* | | |
| with Dolby Digital | Dolby Digital bitstream | | 48 kHz, 16 bit Linear PCM |
| SVCD, VCD, CD | 44.1 kHz, 16 bit Linear PCM/48 kHz, 16 bit Linear PCM | | |
| CD with DTS | DTS bitstream | 44.1 kHz, 16 bit Linear PCM | |
| MP3/WMA/WAV/MPEG-1/MPEG-2 disc/file | 32 kHz/44.1 kHz/48 kHz, 16 bit Linear PCM | | |
| ASF disc/file | 32 kHz, 16 bit Linear PCM | | |
| DivX disc/file | | | |
| with MP2, MP3 | 32 kHz/44.1 kHz/48 kHz, 16 bit Linear PCM | | |
| with Dolby Digital | Dolby Digital bitstream | | 32 kHz/44.1 kHz/48 kHz, 16 bit Linear PCM |

* While playing some DVDs, digital signals may be emitted at 20 bits or 24 bits (at their original bit rate) through the OPTICAL DIGITAL OUTPUT terminal if the discs are not copy-protected.

Language Code List

| | | | | |
|---------------------------|------------------------|----------------------------|--------------------------|----------------------|
| AA Afar | FI Finnish | KO Korean (KOR) | PA Panjabi | TG Tajik |
| AB Abkhazian | FJ Fiji | KS Kashmiri | PS Pashto, Pushto | TH Thai |
| AF Afrikaans | FO Faroese | KU Kurdish | PT Portuguese | TI Tigrinya |
| AM Ameharic | FY Frisian | KY Kirghiz | QU Quechua | TK Turkmen |
| AR Arabic | GA Irish | LA Latin | RM Rhaeto-Romance | TL Tagalog |
| AS Assamese | GD Scots Gaelic | LN Lingala | RN Kirundi | TN Setswana |
| AY Aymara | GL Galician | LO Laothian | RO Rumanian | TO Tonga |
| AZ Azerbaijani | GN Guarani | LT Lithuanian | RW Kinyarwanda | TR Turkish |
| BA Bashkir | GU Gujarati | LV Latvian, Lettish | SA Sanskrit | TS Tsonga |
| BE Byelorussian | HA Hausa | MG Malagasy | SD Sindhi | TT Tatar |
| BG Bulgarian | HI Hindi | MI Maori | SG Sangho | TW Twi |
| BH Bihari | HR Croatian | MK Macedonian | SH Serbo-Croatian | UK Ukrainian |
| BI Bislama | HY Armenian | ML Malayalam | SI Singhalese | UR Urdu |
| BN Bengali, Bangla | IA Interlingua | MN Mongolian | SL Slovenian | UZ Uzbek |
| BO Tibetan | IE Interlingue | MO Moldavian | SM Samoan | VI Vietnamese |
| BR Breton | IK Inupiak | MR Marathi | SN Shona | VO Volapuk |
| CA Catalan | IN Indonesian | MS Malay (MAY) | SO Somali | WO Wolof |
| CO Corsican | IS Icelandic | MT Maltese | SQ Albanian | XH Xhosa |
| CY Welsh | IW Hebrew | MY Burmese | SR Serbian | YO Yoruba |
| DA Danish | JI Yiddish | NA Nauru | SS Siswati | ZU Zulu |
| DZ Bhutani | JW Javanese | NE Nepali | ST Sesotho | |
| EL Greek | KA Georgian | NL Dutch | SU Sundanese | |
| EO Esperanto | KK Kazakh | NO Norwegian | SV Swedish | |
| ET Estonian | KL Greenlandic | OC Occitan | SW Swahili | |
| EU Basque | KM Cambodian | OM (Afan) Oromo | TA Tamil | |
| FA Persian | KN Kannada | OR Oriya | TE Telugu | |

Specifications

Amplifier section

Output Power:

FRONT SPEAKERS: 185 W per channel, min. RMS, driven into 4 Ω at 1 kHz with no more than 10% total harmonic distortion.

CENTER SPEAKER:

CA-DXU20: 160 W per channel, min. RMS, driven into 6 Ω at 1 kHz with no more than 10% total harmonic distortion.

CA-DXU9: 50 W per channel, min. RMS, driven into 6 Ω at 1 kHz with no more than 10% total harmonic distortion.

SURROUND SPEAKERS:

CA-DXU20: 160 W per channel, min. RMS, driven into 6 Ω at 1 kHz with no more than 10% total harmonic distortion.

CA-DXU9: 50 W per channel, min. RMS, driven into 6 Ω at 1 kHz with no more than 10% total harmonic distortion.

SUBWOOFERS: 185 W, min. RMS, driven into 4 Ω at 63 Hz with no more than 10% total harmonic distortion.

Digital output:

OPTICAL DIGITAL OUTPUT:

-21 dBm to -15 dBm (660 nm \pm 30 nm)

Digital input: (REC/PLAY)

Audio input sensitivity/Impedance

(Measured at 1 kHz, with tape recording signal 400 mV)

AUX(STEREO): 400 mV/47 k Ω

MIC1/MIC2: 3.0 mV/50 k Ω

VIDEO OUT:

Color system: PAL/PAL PROG/NTSC/NTSC PROG selectable

VIDEO (composite): 1 V(p-p)/75 Ω

S-VIDEO: Y (luminance) 1 V(p-p)/75 Ω

C (chrominance, burst)

PAL 0.3 V(p-p)/75 Ω

NTSC 0.286 V(p-p)/75 Ω

COMPONENT (Interlace/Progressive):

(Y) 1 V(p-p)/75 Ω

(Pb/Pk) 0.7 V(p-p)/75 Ω

Speaker Terminals: 4 Ω - 16 Ω (front speakers/subwoofers)

6 Ω - 16 Ω (surround/center speakers)

Tuner section

FM tuning range: 87.50 MHz - 108.00 MHz

AM (MW) tuning range: 531 kHz - 1 710 kHz (at 9 kHz)

530 kHz - 1 710 kHz (at 10 kHz)

For Saudi Arabia: 531 kHz to 1 602 kHz (9 kHz)

530 kHz to 1 600 kHz (10 kHz)

Disc/file player section

Region codes: Middle East: 2

South East Asia: 3

Central and South America, Australia: 4

Playable disc:

DVD Video/CD/VCD/SVCD

CD-R/CD-RW (CD/VCD/SVCD/MP3/WMA/WAV/JPEG/

MPEG-1/MPEG-2/ASF/DivX format)

CD-ROM (MP3/WMA/WAV/JPEG/MPEG-1/MPEG-2/ASF/

DivX format)

DVD-R/-RW (DVD-VR/DVD Video/MP3/WMA/WAV/JPEG/

MPEG-1/MPEG-2/ASF/DivX format)

+R/+RW (DVD Video/MP3/WMA/WAV/JPEG/MPEG-1/

MPEG-2/ASF/DivX format)

DVD-ROM (DVD Video/MP3/WMA/WAV/JPEG/MPEG-1/

MPEG-2/ASF/DivX format)

Playable file:

MP3, WMA, WAV, JPEG, MPEG-1, MPEG-2, ASF, DivX format

Dynamic range: 80 dB

Horizontal resolution: 500 lines

Wow and flutter: Immeasurable

USB storage section

USB specification: Compatible with USB 2.0 Full Speed

Compatible device: Mass Storage Class

Compatible file system: FAT16, FAT32

Bus power supply: DC 5 V \pm 500 mA

Cassette deck section

Frequency response

Normal (type I): 50 Hz - 14 000 Hz

Wow and flutter: 0.15% (WRMS)

General

Power requirement: AC 110 V / AC 127 V / AC 220 V / AC 230 V - AC 240 V \sim , (adjustable with the voltage selector), 50 Hz / 60 Hz

For Australia: AC 240 V \sim , 50 Hz

Power consumption:

CA-DXU20: 300 W (at operation) / 22 W (on standby)

CA-DXU9: 270 W (at operation) / 21 W (on standby)

Dimensions (W/H/D) (approx.): 185 mm x 460 mm x 370 mm

Mass (approx.):

CA-DXU20: 11.5 kg

CA-DXU9: 11.4 kg

Supplied Accessories

See page 3.

Design and specifications are subject to change without notice.

- Manufactured under license from Dolby Laboratories. "Dolby", "Pro Logic", "MLP Lossless", and the double-D symbol are trademarks of Dolby Laboratories.
- Manufactured under license under U.S. Patent numbers: 5,451,942; 5,956,674; 5,974,380; 5,978,762; 6,487,535 and other U.S. and worldwide patents issued and pending. DTS and DTS Digital Surround are registered trademarks and the DTS logos and Symbol are trademarks of DTS, Inc. © 1996-2007 DTS, Inc. All Rights Reserved.
- "Official DivX® Ultra Certified product" "Plays all versions of DivX® video (including DivX® 6) with enhanced playback of DivX® media files and the DivX® Media Format" "DivX, DivX Ultra Certified, and associated logos are trademarks of DivX, Inc. and are used under licence."
- Microsoft and Windows Media are either registered trademarks or trademarks of Microsoft Corporation in the United States and/or other countries.
- This product incorporates copyright protection technology that is protected by U.S. patents and other intellectual property rights. Use of this copyright protection technology must be authorized by Macrovision, and is intended for home and other limited viewing uses only unless otherwise authorized by Macrovision. Reverse engineering or disassembly is prohibited.
- "CONSUMERS SHOULD NOTE THAT NOT ALL HIGH DEFINITION TELEVISION SETS ARE FULLY COMPATIBLE WITH THIS PRODUCT AND MAY CAUSE ARTIFACTS TO BE DISPLAYED IN THE PICTURE. IN CASE OF 525 OR 625 PROGRESSIVE SCAN PICTURE PROBLEMS, IT IS RECOMMENDED THAT THE USER SWITCH THE CONNECTION TO THE 'STANDARD DEFINITION' OUTPUT. IF THERE ARE QUESTIONS REGARDING OUR TV SET COMPATIBILITY WITH THIS MODEL 525p AND 625p DVD PLAYER, PLEASE CONTACT OUR CUSTOMER SERVICE CENTER."
- USE OF THIS PRODUCT IN ANY MANNER THAT COMPLIES WITH THE MPEG-4 VISUAL STANDARD IS PROHIBITED, EXCEPT FOR USE BY A CONSUMER ENGAGING IN PERSONAL AND NON-COMMERCIAL ACTIVITIES.

Parts Index

Remote control

| Button | Page | Button | Page |
|-------------------|------|-----------------------|---------------------------------|
| AUDIO | 29 | MIC MIX | 26 37 |
| TV | 30 | MIC VOL +, - | 53 37, 39, 40 |
| | 7 | ON SCREEN | 42 24 |
| | 39 | FILE TYPE | 18 10 |
| | 38 | REPEAT | 46 22, 28 |
| | 9 | REPEAT A-B | 47 22 |
| | 9 | RESERVE | 28 41 |
| | 10 | RETURN | 14 12 |
| | 37 | REVERSE MODE | 33 12, 31 |
| | 41 | SCAN MODE | 20 6 |
| ENTER/SET | 41 | SET UP | 12 44 |
| Number buttons | 43 | SLEEP | 51 43 |
| | 33 | SLOW | 38 19 |
| ANGLE | 44 | SLOW | 39 19 |
| AUDIO/MPX | 16 | SOUND MODE | 22 14 |
| AUDIO/TV selector | 35 | SUB TITLE | 17 18 |
| AUDIO VOL +, - | 36 | SUBWOOFER LEVEL +, - | 49 13 |
| CANCEL | 13 | SURROUND MODE | 23 15 |
| CHANNEL LEVEL | 48 | TAPE-A | 3 8, 12 |
| CLOCK/TIMER | 52 | TAPE-B | 34 8, 12 |
| DISC1-5 | 2 | TITLE/DEL | 42 33, 34, 36 |
| DIMMER | 25 | TOP MENU/PG | 11 11, 27 |
| DISPLAY/CHARA | 24 | TUNER/AUX | 32 8-10 |
| DVD/CD | 8 | TV CHANNEL +, - | 5 46 |
| DVD LEVEL | 19 | TV/VIDEO | 31 46 |
| FADE MUTING | 50 | USB MEMORY | 4 8, 10, 11, 19, 28, 33, 36, 38 |
| FM/PLAY MODE | 37 | VARIO BASS | 21 14 |
| GROUP/TITLE | 15 | Volume buttons for TV | 6 46 |
| KARAOKE SCORING | 1 | VFP | 20 15, 16 |
| KARAOKE SETTING | 54 | V.MASKING | 55 38 |
| MENU/PL | 40 | VOCAL SUPPORT | 27 38 |
| | | ZOOM | 45 19, 28 |

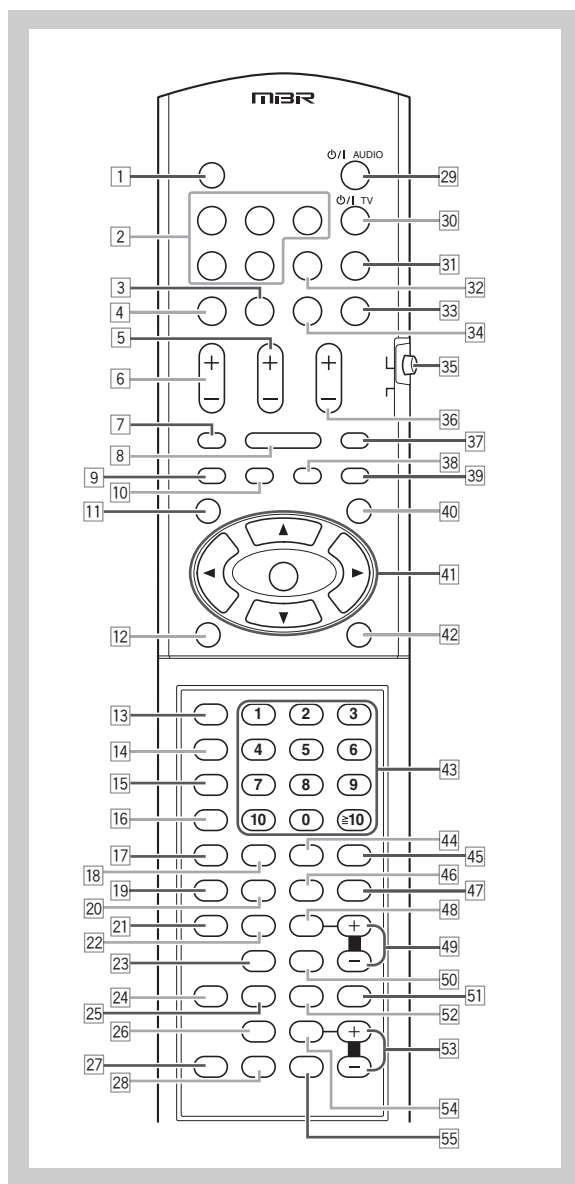

Main unit

| Button | | Page | Button | | Page |
|-----------------------|----|-------------------------------|----------------------|----|---------------------------|
| ⏻/STANDBY | ② | 8 | MIC1, MIC2 | ⑱ | 37-41 |
| -PRESET/◀◀ | ⑳㉘ | 9-12, 21, 38 | MIC LEVEL | ⑲ | 37, 40, 41 |
| PRESET+/▶▶ | | | +, - | | |
| ⏪ | ⑳ | 10, 19, 21, 28, 39 | PHONES | ⑦ | 8 |
| ■ | ㉑ | 10, 12, 21, 22, 28, 30-32, 38 | PUSH OPEN ▲ | ⑯⑰ | 12, 31 |
| -TUNING/◀◀ | ㉒㉓ | 9, 11, 12, 19, 22, 25 | REC START/STOP | ⑤ | 31, 32, 37 |
| TUNING+/▶▶ | | | CD ▶ USB REC | ⑭ | 30 |
| Display | ⑩ | 7 | SOUND MODE | ⑬ | 14 |
| Disc trays | ① | 10, 22 | SUBWOOFER LEVEL ⊕, ⊖ | ⑪ | 13 |
| ⏮ (REC/PLAY) terminal | ③ | 6, 10, 30, 33, 36 | SURROUND MODE | ⑫ | 15 |
| AUX | ㉗ | 8 | TAPE-A ◀▶ | ㉓ | 8, 12, 31 |
| DEMO | ㉙ | 6 | TAPE-B ◀▶ | ㉕ | 8, 12, 31 |
| DISC1-5 ▷, ▲ | ⑮ | 10, 11, 22, 30, 32 | USB/DISC REC START | ④ | 32 |
| DUBBING | ⑥ | 31 | USB MEMORY ▷ | ㉒ | 8, 10, 11, 19, 28, 32, 38 |
| DVD/CD ▷ | ㉑ | 8, 10, 11, 19-21, 28, 38, 41 | VARIO BASS | ⑧ | 14 |
| ECHO LEVEL +, - | ⑳ | 39 | VOLUME +, - | ㉔ | 8, 9, 37 |
| FM/AM | ㉖ | 9, 10 | | | |
| KARAOKE SCORING | ⑨ | 38, 39 | | | |

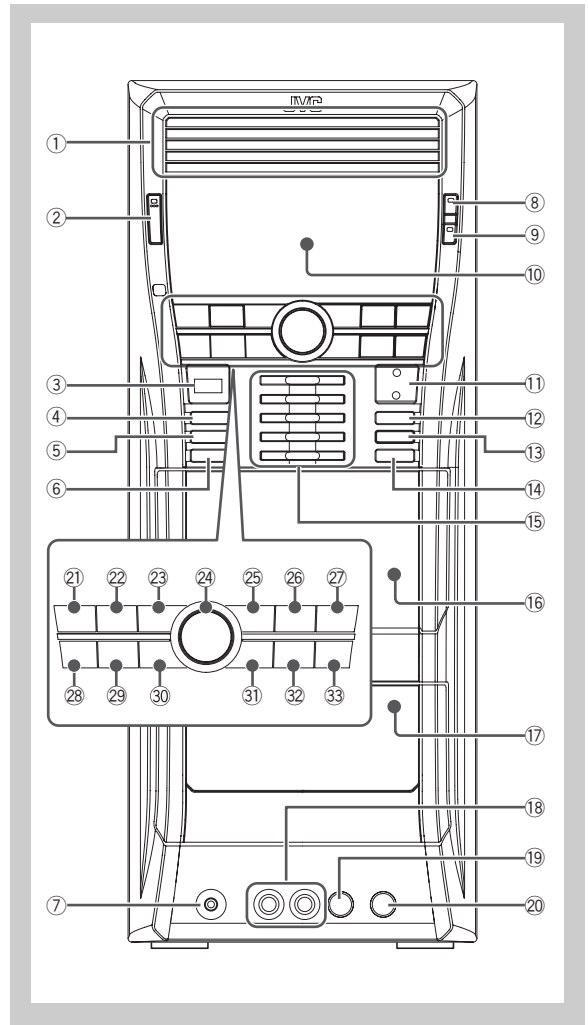

Mains (AC) Line Instruction (not applicable for Europe, U.S.A., Canada, and U.K.)

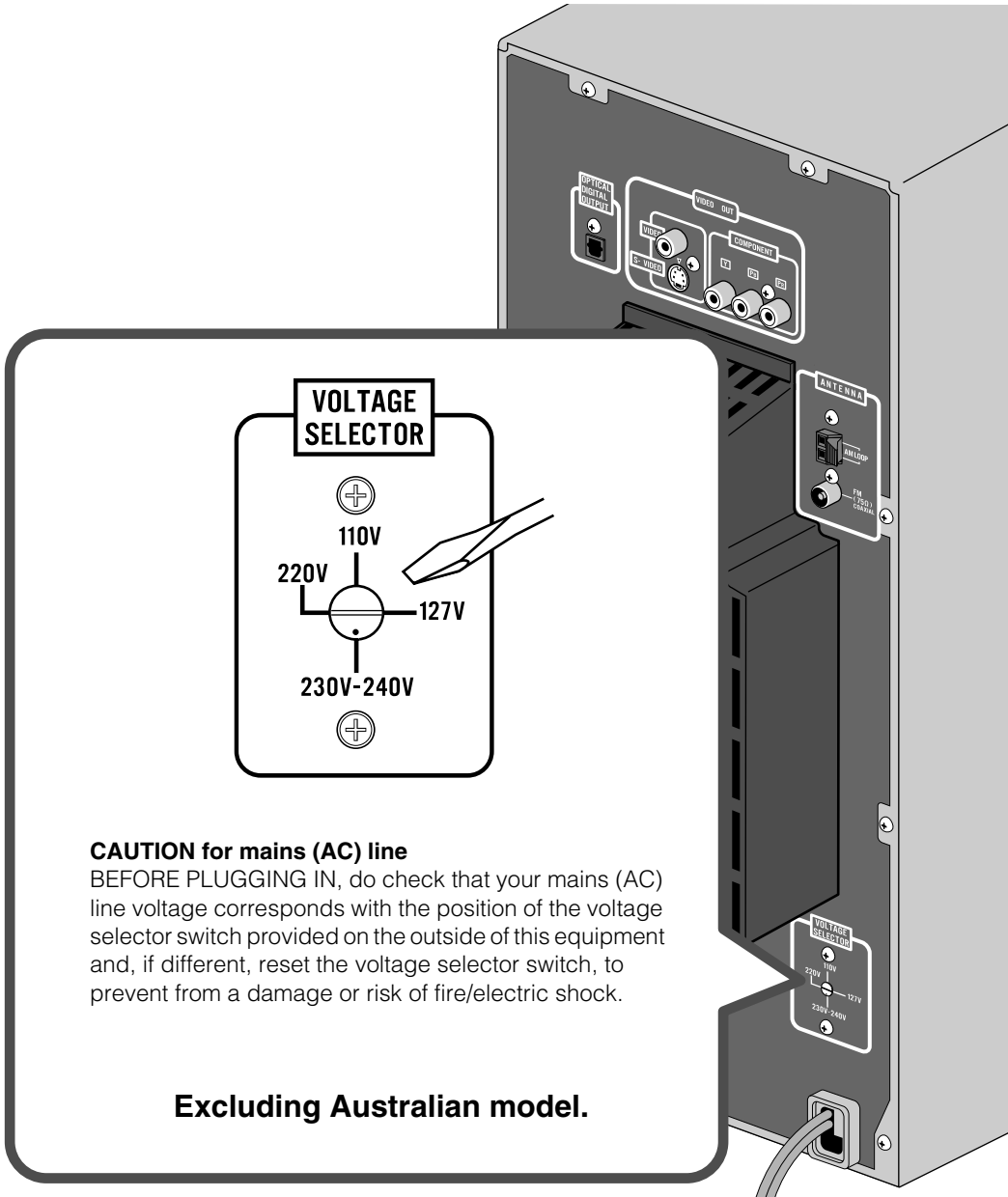

JVC